

700 V CoolMOS™ P7

First 700 V CoolMOS™ MOSFET developed on 300 mm for low power applications

About this document

Scope and purpose

Infineon is introducing its first 700 V high voltage MOSFET (Metal Oxide Semiconductor Field Effect Transistor) solution developed and produced on 300 mm for low power applications. 700 V CoolMOS™ P7 offers a price competitive solution for consumer applications such as chargers and adapters in the power range from 10 W to 75 W. These power converters are typically based on flyback topologies. 700 V CoolMOS™ P7 is no longer a multi purpose MOSFET as it has become known, it is now a tailored technology for flyback and DCM (discontinuous current mode) PFC applications and must not be used in any half bridge or full bridge configuration in which hard commutation on a conducting body diode can occur. The portfolio includes popular packages which are a direct replacement for existing MOSFETs, allowing improved performance while offering lower prices in comparison to other technologies targeting this low power market. 700 V CoolMOS™ P7 is able to fit into several low power packages such as SOT-223 with the lowest $R_{DS(on)}$ available on the market. Furthermore, it will be included in Infineon newest package concept; the IPAK with an isolated lead standoff.

This application note provides an explanation of the new CoolMOS™ technology. The goal of this application note is to describe all technical and technological benefits 700 V CoolMOS™ P7 can offer in comparison to older technologies and competitor products. Furthermore, it will present the evaluation of a customer charger to show the performance that can be achieved with 700 V CoolMOS™ P7 with respect to thermal performance, efficiency and electromagnetic interference behavior.

700 V CoolMOS™ P7 is the right solution for all the main challenges every designer of low power applications is facing, keeping BOM costs low while not sacrificing technical specifications and meeting safety requirements.

Intended audience

Switched mode power supply design engineers.

Table of contents

About this document1

Table of contents2

1 Target applications3

1.1 CCM flyback (fixed frequency)3

1.2 DCM flyback (fixed frequency)5

1.3 QR flyback (variable frequency).....6

2 Technology parameters8

2.1 Q_g – gate charge8

2.2 $R_{DS(on)}$ – temperature dependency of on-state resistance8

2.3 E_{oss} – energy stored in output capacitance9

2.4 Q_{oss} – charge stored in output capacitance10

2.5 Transfer characteristics11

2.6 Avalanche12

2.7 Early channel shutdown14

3 Benchmarking of 700 V CoolMOS™ P7 in low power designs.....15

3.1 12 W customer charger.....15

3.1.1 Efficiency / thermals15

3.1.2 Radiated EMI.....16

3.2 35 W Infineon adapter16

3.2.1 Efficiency / thermals17

3.2.2 Radiated EMI.....18

3.3 Benchmarking summary (key facts) for all measurements.....18

4 Portfolio19

5 Design considerations.....20

5.1 Paralleling of MOSFETs20

5.2 Source impedance (source bead)20

5.3 Target applications20

Revision history21

1 Target applications

As already anticipated, 700 V CoolMOS™ P7 is a tailored technology for flyback topologies and DCM PFC. This chapter will introduce the main target market which are charger and adapter applications from 10 W to 75 W. The difference between charger and adapter is the output voltage used. Chargers typically operate between 5 V and 12 V output and adapters are around 19 V. All these applications typically use flyback topologies. There are three main flyback structures that have the highest market share. First the CCM (continuous current mode) flyback, secondly fixed frequency DCM flyback and quasi resonant flyback which will be introduced in the next section.

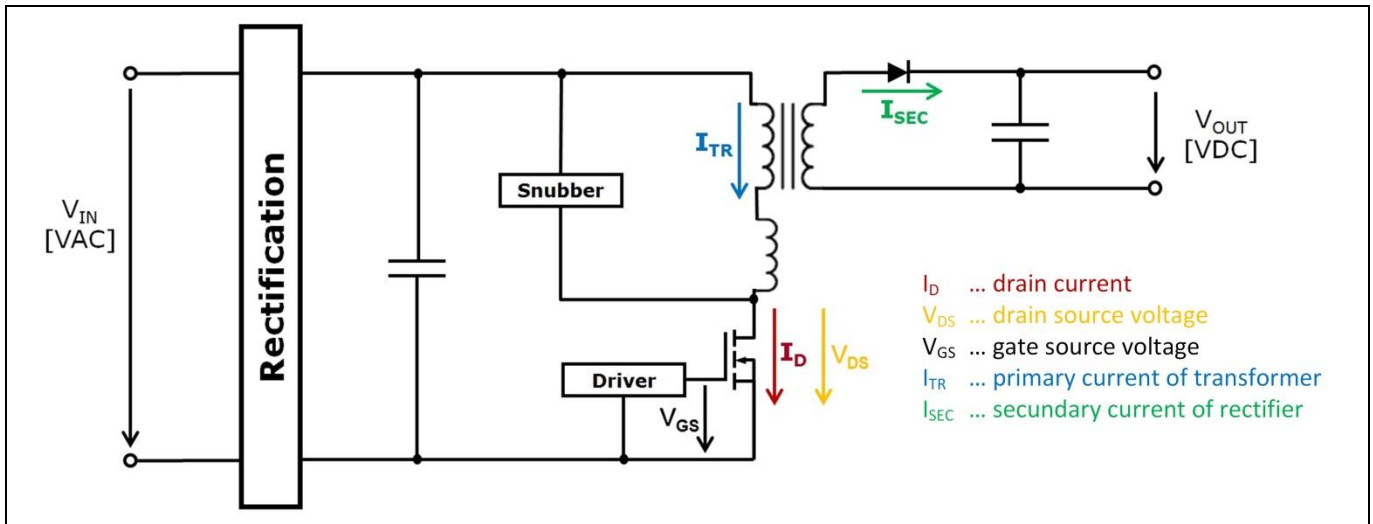

Figure 1 Flyback simplified schematic

1.1 CCM flyback (fixed frequency)

A CCM flyback is a fixed frequency flyback and typically used for adapters in the higher power range above 45 W. In this flyback the current through the main transformer (I_{TR}) never reaches 0 A in steady state operation as can be seen in Figure 2. This leads to a fully hard switching topology where the E_{oss} (energy stored in output capacitance at certain voltage) behavior of 700 V CoolMOS™ P7 shows its best performance. Fixed frequency controllers are typically 3 – 4 times lower cost than quasi-resonant controllers. In order to regulate the output voltage the duty cycle is changed depending on the output load. It should be considered that a CCM flyback can also operate in DCM (discontinuous current mode) in light load operation, depending on the value of the primary windings and inductance of the main transformer. The principle of operation and simplified waveforms are shown in Figure 2.

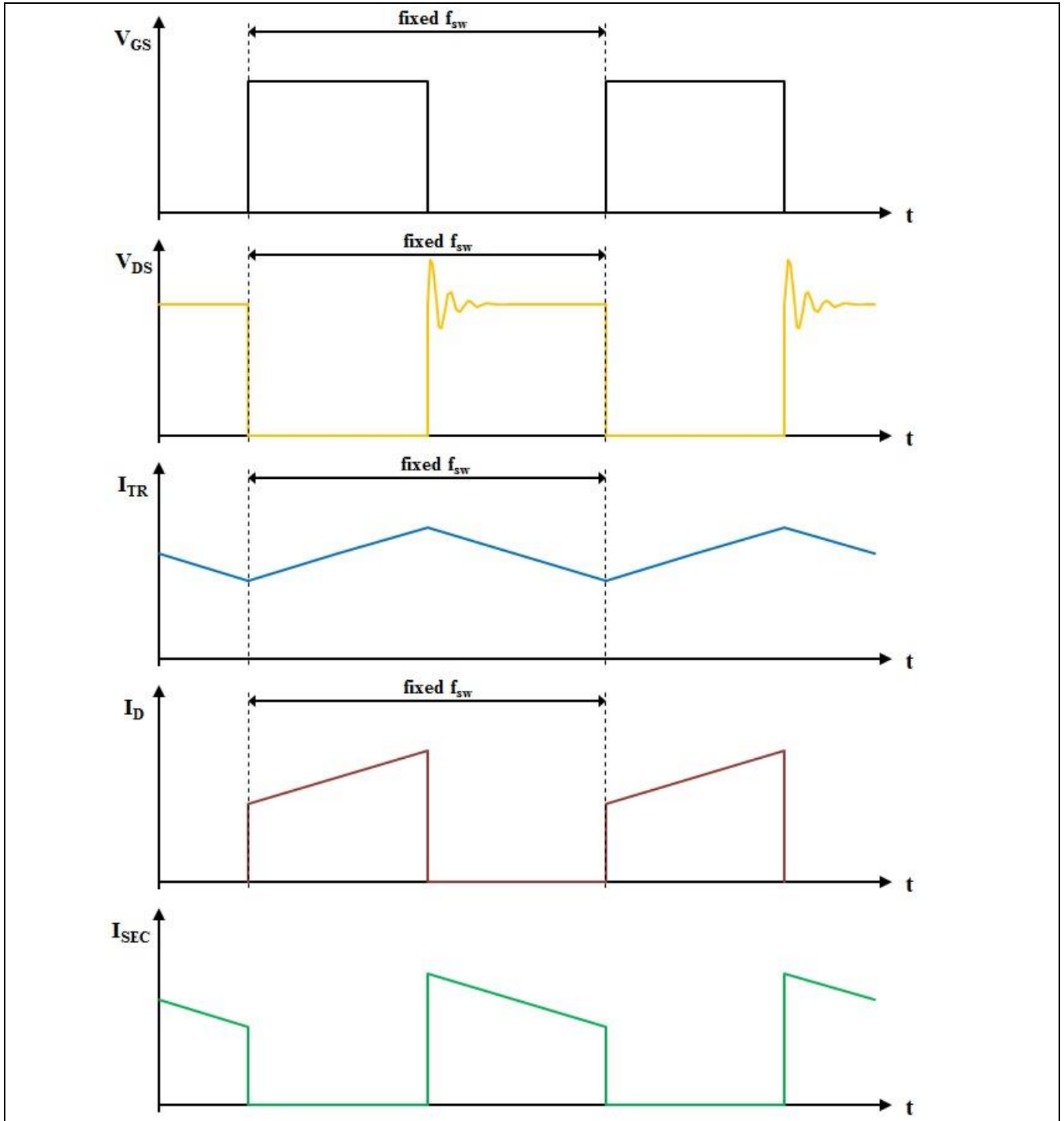

Figure 2 CCM flyback principle of operation

Target applications

1.2 DCM flyback (fixed frequency)

As already mentioned, the DCM flyback is typically used at lower output loads. In a standard DCM flyback the output is also regulated by the duty cycle. This setup is not used frequently due to new efficiency standards. Also second sourcing is not always easy to achieve as the E_{oss} losses from a MOSFET contributes tremendously to the overall efficiency and is different for all MOSFETs available on the market. The principle of operation and simplified waveforms are shown in Figure 3 below.

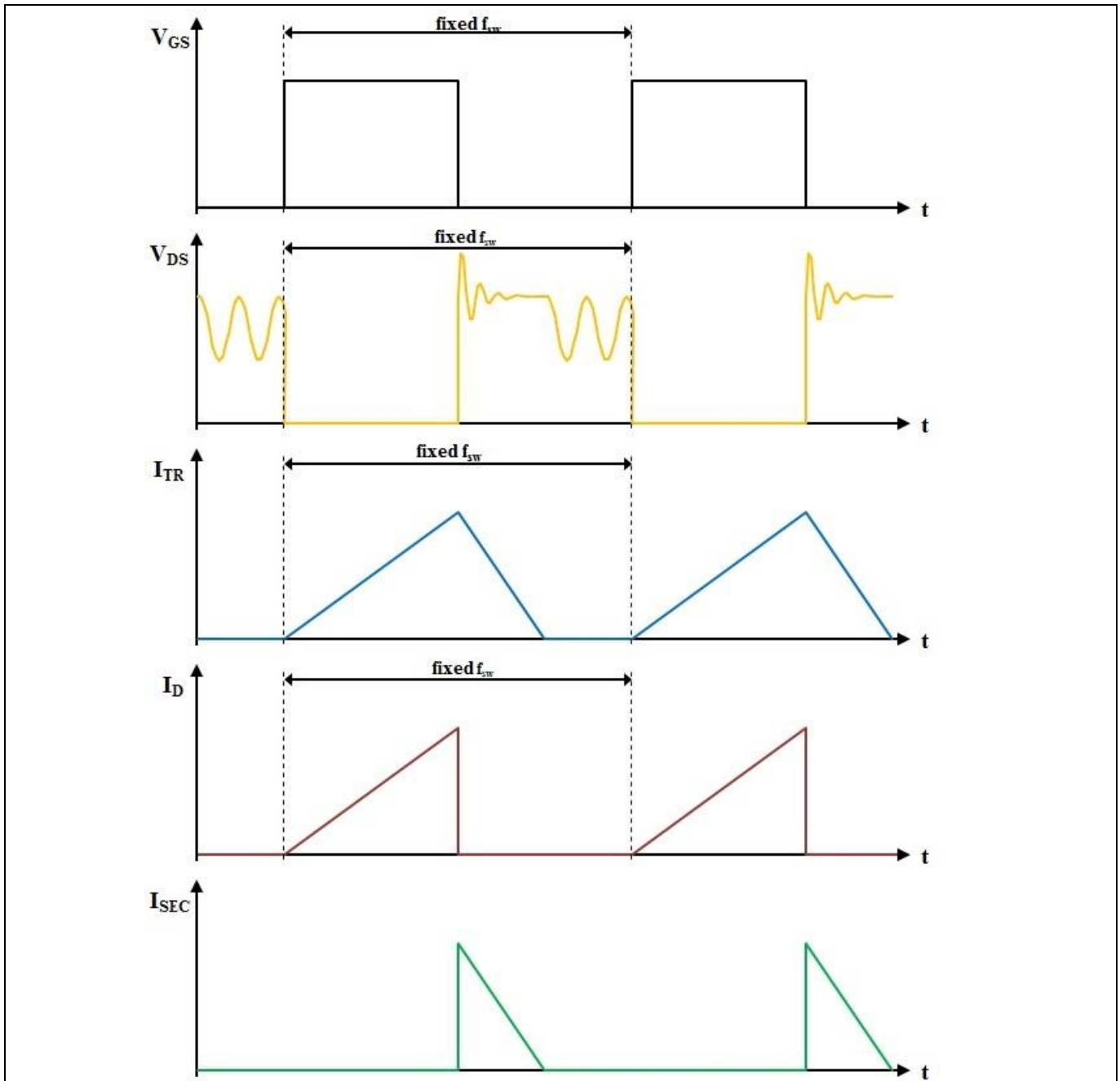

Figure 3 DCM flyback principle of operation

Target applications

1.3 QR flyback (variable frequency)

Quasi-resonant (QR) flyback topologies are the most commonly used topologies for low power chargers. They offer better performance due to lowering the switching losses. A QR flyback can only operate in DCM, because it switches the MOSFET on during the oscillation phase of drain node capacitance and transformer main inductance when the current through the main transformer is 0 A. The difference between a standard DCM flyback and QR operation is, that the MOSFET is able to turn on at minimum V_{DS} (drain-source voltage) which reduces the E_{oss} losses. This behavior is called valley switching and can be seen in the following figure.

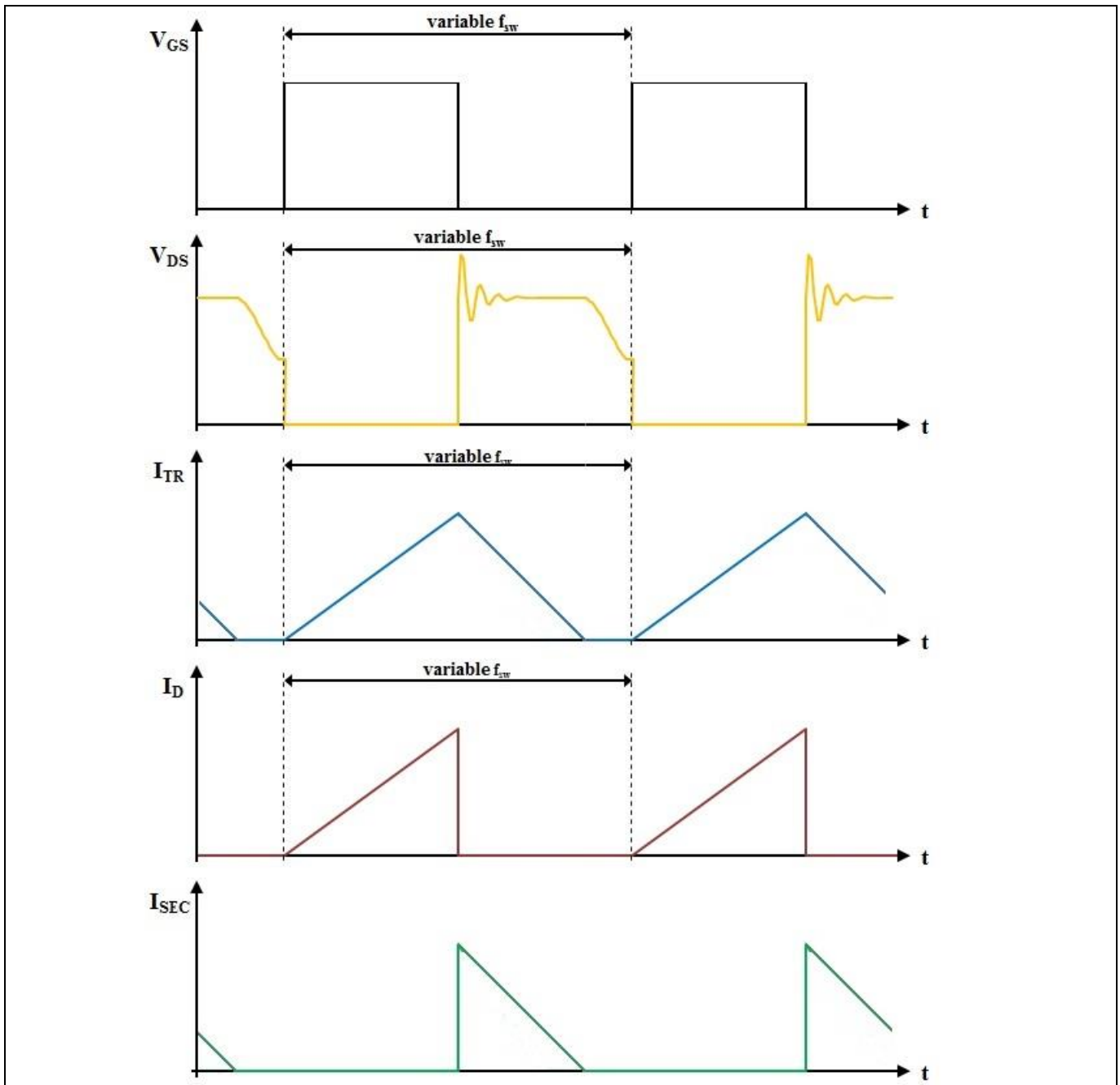

Figure 4 QR flyback principle of operation

Typically, at very light loads, the MOSFET turns on at the later valley while at heavy loads the MOSFET turns on in the first valley. As described, the V_{DS} oscillation is given by the capacitance value on the drain node and is influenced by the output capacitance of the MOSFET (C_{oss}). In this case the switching frequency can be influenced by MOSFET selection.

700 V CoolMOS™ P7

First 700 V CoolMOS™ MOSFET developed on 300 mm for low power applications



Target applications

At the moment there are other flyback solutions, such as zero voltage switching flyback or active clamp flyback, available but these solutions are not considered in this application note. 700 V CoolMOS™ P7 is not intended to be used in half bridge or full bridge configuration where a hard commutation of a conducting body diode can occur due to the ruggedness of the body diode.

2 Technology parameters

This chapter will describe all technology related parameters that influence the behavior in the target applications. Additionally it is worth mentioning 700 V CoolMOS™ P7 offers an ESD protection diode which gives at least class 1C in the human body model for all $R_{DS(on)}$ classes and offers class 2 for all products with $R_{DS(on)}$ of 600 mΩ or less.

2.1 Q_g – gate charge

The gate charge influences the driving losses, which can tremendously influence the efficiency during light load operation or increased switching frequency.

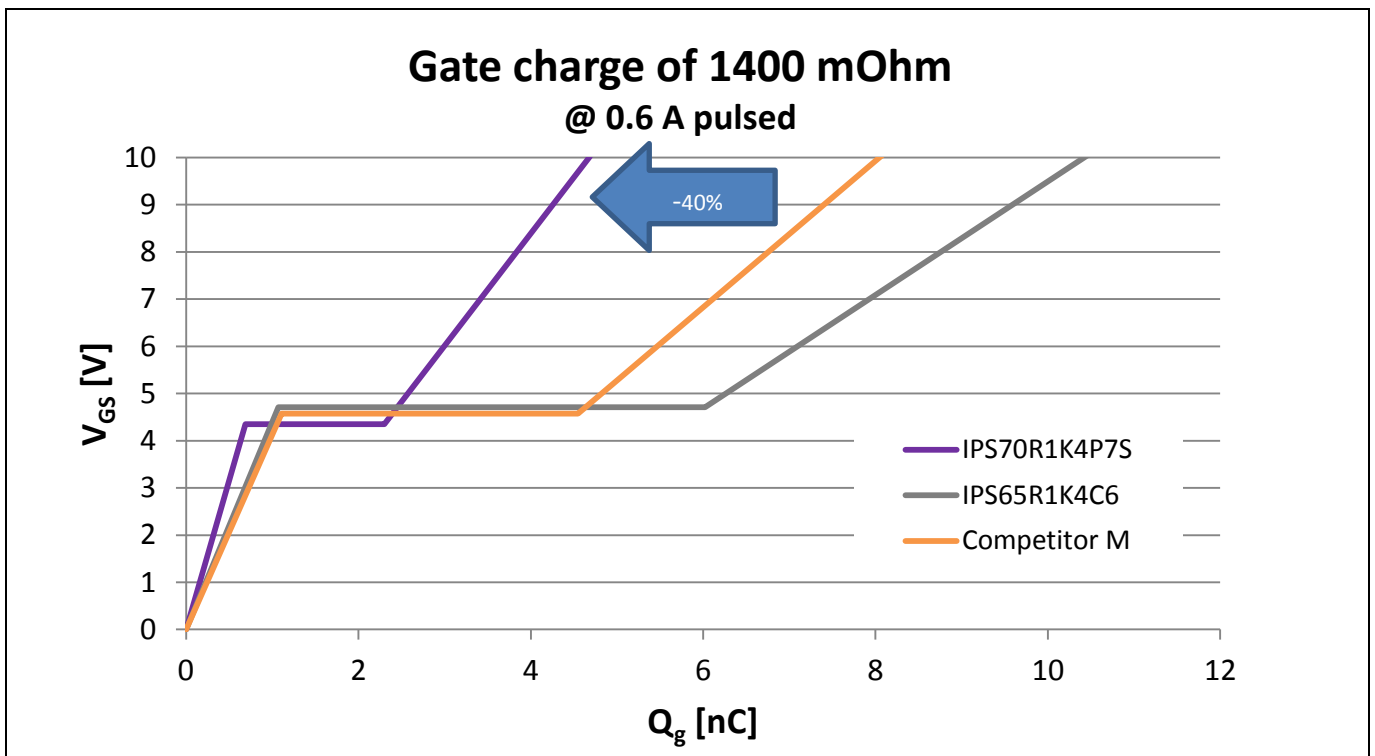

Figure 5 Gate charge of 1400 mΩ devices at 0.6 A pulsed

As can be seen, 700 V CoolMOS™ P7 shows the lowest Q_g in comparison to all former Infineon and main competitor technologies. With this behavior P7 can be an enabler to move to higher switching frequencies (>100 kHz) which can be beneficial to reduce the magnetic components of the design, leading to smaller form factors or higher power densities. It is clear that the driving losses are reduced by at least 40% in comparison to competitor devices.

2.2 $R_{DS(on)}$ – temperature dependency of on-state resistance

Also in the lower power ranges the conduction losses have an influence on the efficiency and the thermal behavior of the overall system especially at lower input voltages such as 90 V_{AC} or 110 V_{AC}. In this case 700 V CoolMOS™ P7 can offer a significant value proposition. As defined by the MOSFET structure, 700 V CoolMOS™ P7 offers the lowest $R_{DS(on)}$ change driven by increasing junction temperature. Figure 6 below shows this behavior.

Technology parameters

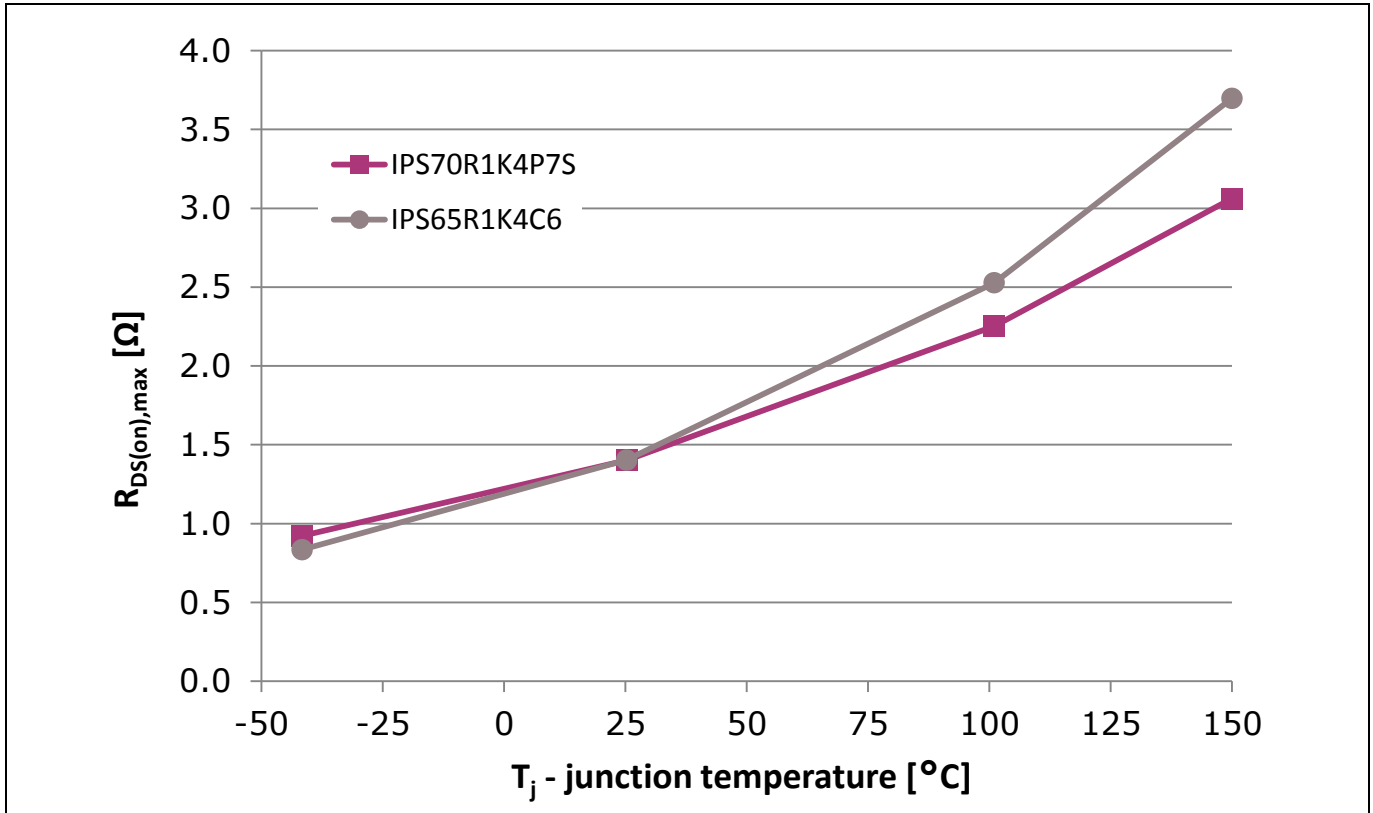

Figure 6 R_{DS(on)} behavior over junction temperature

At 150°C junction temperature the 700 V CoolMOS™ P7 shows around 21% lower maximum R_{DS(on)} when compared to Infineon's CoolMOS™ C6 family. This key parameter results in the reduction of MOSFET conduction losses in any design available.

2.3 E_{OSS} – energy stored in output capacitance

E_{OSS} is one of the main loss contributors during the turn on of the MOSFET. This is the energy that translates into losses during turn on at a certain V_{DS} voltage. In QR flyback converters, there are no E_{on} losses as there is no overlap between I_D and V_{DS} as the current through the main transformer is 0 A. Nevertheless, additional losses are generated at every turn on based on the amount of energy stored in the output capacitance.

Technology parameters

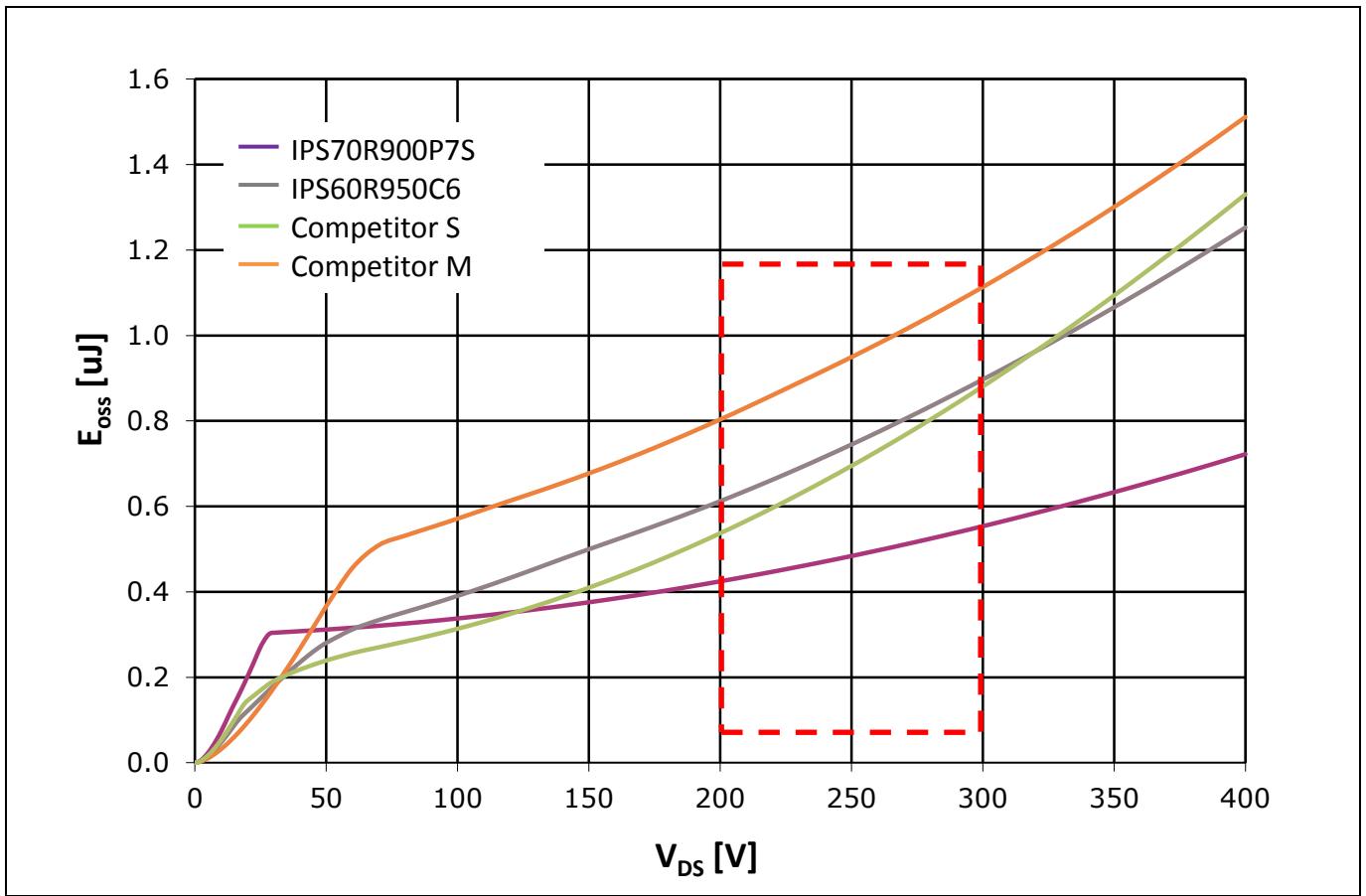

Figure 7 E_{oss} comparison of 900 mΩ devices

From the diagram it can be seen that 700 V CoolMOS™ P7 offers the lowest E_{oss} starting from 50 V V_{DS}. Normally it is not possible to have a real ZVS turn-on of the MOSFET as there would be the need to increase the reflected voltage from the secondary side to the primary side tremendously. This would also increase the bulk voltage and the drain source voltage peak during turn-off. Therefore turn-on V_{DS} at low line is typically between 50 V and 100 V and at high line 200 V to 300 V resulting in around 50% lower turn on losses than the main competitor M and around 25% lower than competitor S.

As these additional losses are present at every turn on, 700 V CoolMOS™ P7 also offers the possibility to achieve higher switching frequencies as already described in the gate charge section of this chapter.

2.4 Q_{oss} – charge stored in output capacitance

It was already illustrated that valley switching is typically above 50 V drain-source voltage.

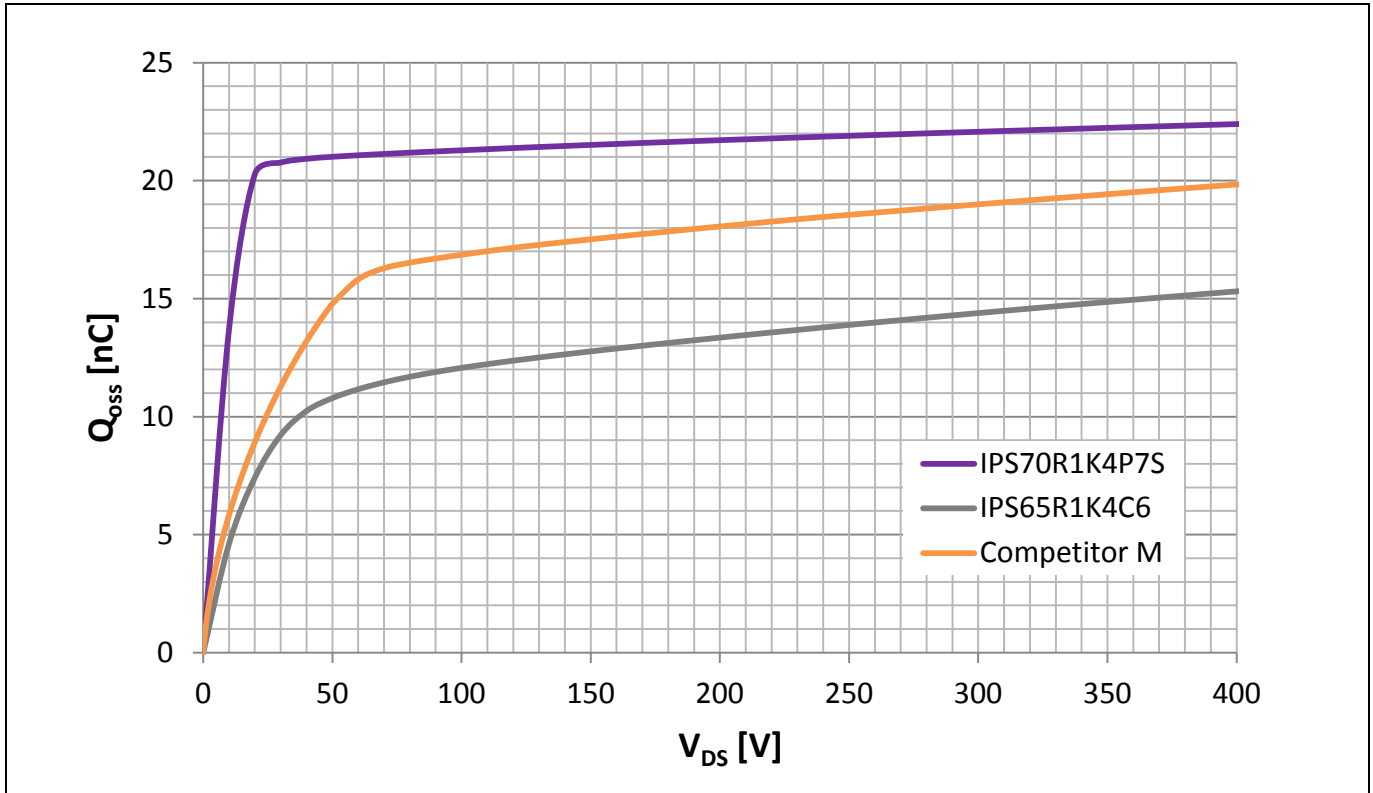

Figure 8 Q_{oss} comparison of 1400 mΩ devices

Recirculating current also leads to additional passive losses from 50 V onwards. In order to have the lowest possible recirculating current, the extremely small Q_{oss} (1.7 nC) between 50 V and 400 V present in 700 V CoolMOS™ P7 needs the lowest circulating current to charge and discharge the C_{oss} in comparison to competitor devices from 50 V V_{DS} upwards.

2.5 Transfer characteristics

Around 95% of all flyback converters use peak current control. This means that the controller sends the turn off signal to the gate driver at a certain current value present in the primary inductance of the main transformer and MOSFET. There is a well-known failure mode in charger and adapter applications when the gate source voltage drops during burst mode operation and the MOSFET is unable to carry sufficient current to reach the peak current. In this case the MOSFET operates in the linear region and does not turn off resulting in destruction of the MOSFET / application. In addition, 700 V CoolMOS™ P7 can offer a very narrow $V_{GS(th)}$ (gate source threshold voltage) window from 2.5 V to 3.5 V with a typical value of 3 V.

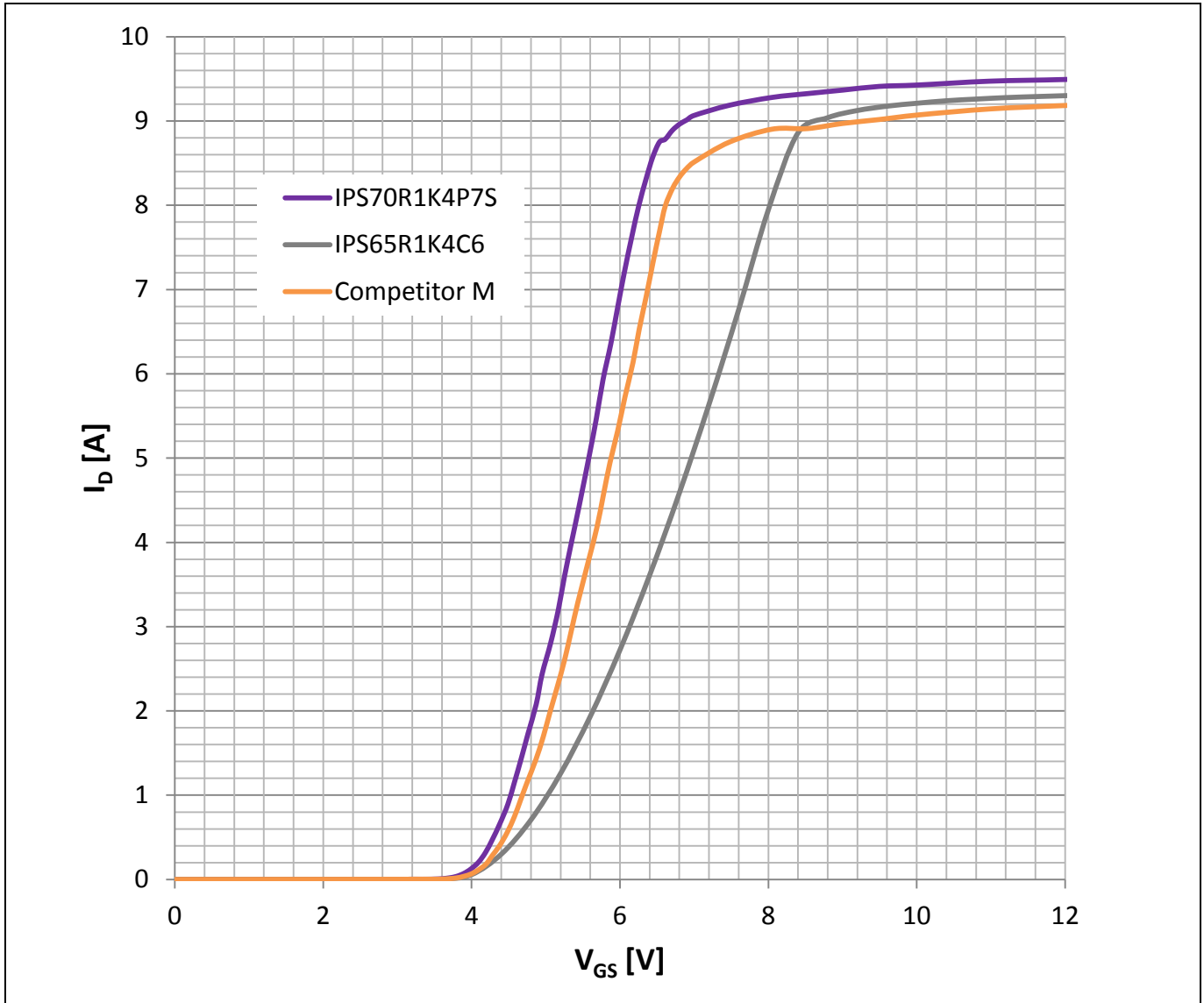

Figure 9 Transfer characteristics comparison of 1400 mΩ devices at 25°C

700 V CoolMOS™ P7 shows the best in class transconductance behavior due to unmatched current capability at low gate-source voltage. Furthermore, this leads to the possibility to reduce the gate source voltage intentionally in order to minimize the overall driving losses and the possibility to comply with new no-load operation requirements.

2.6 Avalanche

The general recommendation is to keep V_{DS} below the $V_{BR(DSS)}$ (breakdown voltage) rating of the product shown in datasheets. As market analysis has shown, 80% derating is used in all charger and adapter applications during standard operation and is permitted to increase to 100% during transients. This results in an assumption that avalanche is not present in these applications. Nevertheless, there are also surge tests performed on customer applications during qualification that are only a pass/fail test where the MOSFET is not permitted to be the root cause of a failure. In this case, it is difficult to verify if the MOSFET is driven into avalanche operation or not. It is always recommended to use a snubber network to limit the drain source voltage overshoot. This should be dimensioned so that the snubber is active before the breakdown voltage is reached as shown in Figure 10.

Technology parameters

Avalanche operation in a flyback can only be driven by the leakage inductance of the transformer, which is typically in the range of 1-2% of the main transformer primary inductance. Based on this there are much lower energies and inductance values as shown in previous MOSFET datasheets.

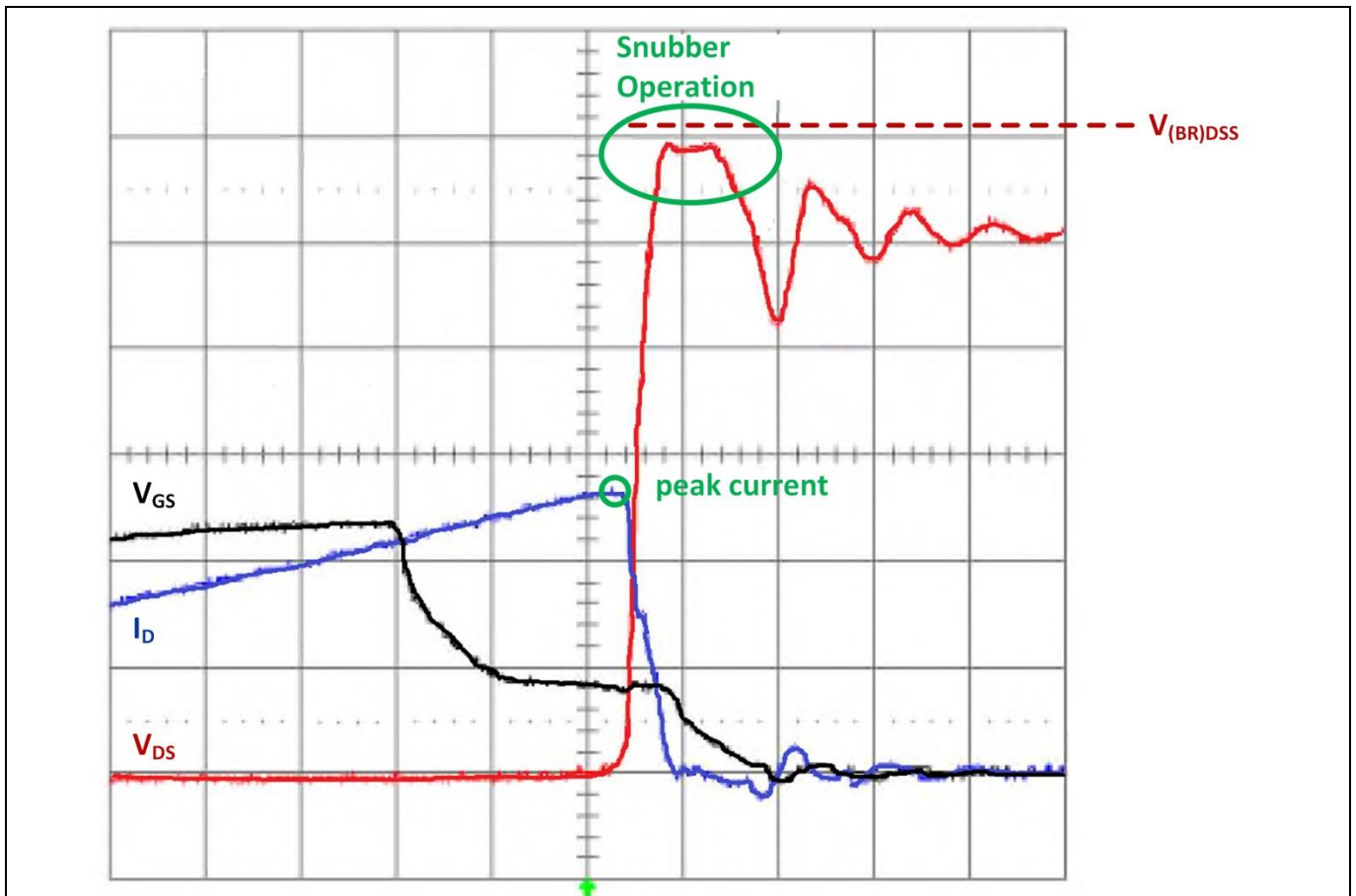

Figure 10 Flyback converter turn off avalanche operation

As already discussed in several publications destruction by avalanche energy with high energy and high inductance values is not typical for any SMPS application. Thus Infineon adapts the avalanche conditions in all new datasheets for new technologies to meet the application design environment. 700 V CoolMOS™ P7 includes the current destruction mechanism rating in all datasheets. The current during the avalanche is limited by the peak current control and can therefore quite easily controlled.

In order to determine if 700 V CoolMOS™ P7 is ready for surge qualification Infineon have tested several end customer designs and applied surge qualification directly to customer designs. The following table represents the results of this test up to design failure during surge qualification.

Table 1 Surge verification tests done in end-customer applications till design failure

Customer applications	L-> N surge voltage	Fail	Note
10 W charger	1.5 kV	fuse, bulk cap, bridge diode	no MOSFET destruction
12 W quick charger	2 kV	fuse, bulk cap, bridge diode	no MOSFET destruction
15 W charger	3 kV	bridge diode	no MOSFET destruction
18 W quick charger	2.5 kV	fuse, bulk cap, bridge diode	no MOSFET destruction

Technology parameters

18 W quick charger 2	2 kV	fuse, bridge diode	no MOSFET destruction
24 W quick charger	1.8 kV	bridge diode	no MOSFET destruction

As can be seen in all surge tests, 700 V CoolMOS™ P7 survived the surge event. Generally, designers should always use a snubber network in order to prevent avalanche operation of the MOSFET.

2.7 Early channel shutdown

In some $R_{DS(on)}$ classes, 700 V CoolMOS™ P7 will have an $R_{g,int}$ (integrated gate resistor). In order to fit to Infineon's "ease of use" requirement this value can be seen in all available datasheets. In end applications, external gate resistors are either used to slow down the devices for EMI reasons or for voltage peak limitation. Nevertheless, 700 V CoolMOS™ P7 offers the so-called early channel shutdown. This means that every $R_{DS(on)}$ class has a limit where the switching losses increase with respect to the gate resistance in the gate drive loop. For 700 V CoolMOS™ P7 it is possible to increase the gate resistor without suffering switching loss increase. This is valid for all $R_{DS(on)}$ classes to at least 30 – 40 Ohm on the gate (the sum of internal and external gate resistors). Figure 11 below shows this as a simplified example. Furthermore, the E_{off} value under same test condition of 700 V CoolMOS™ P7 is on average 35% smaller than Infineon's main competitor.

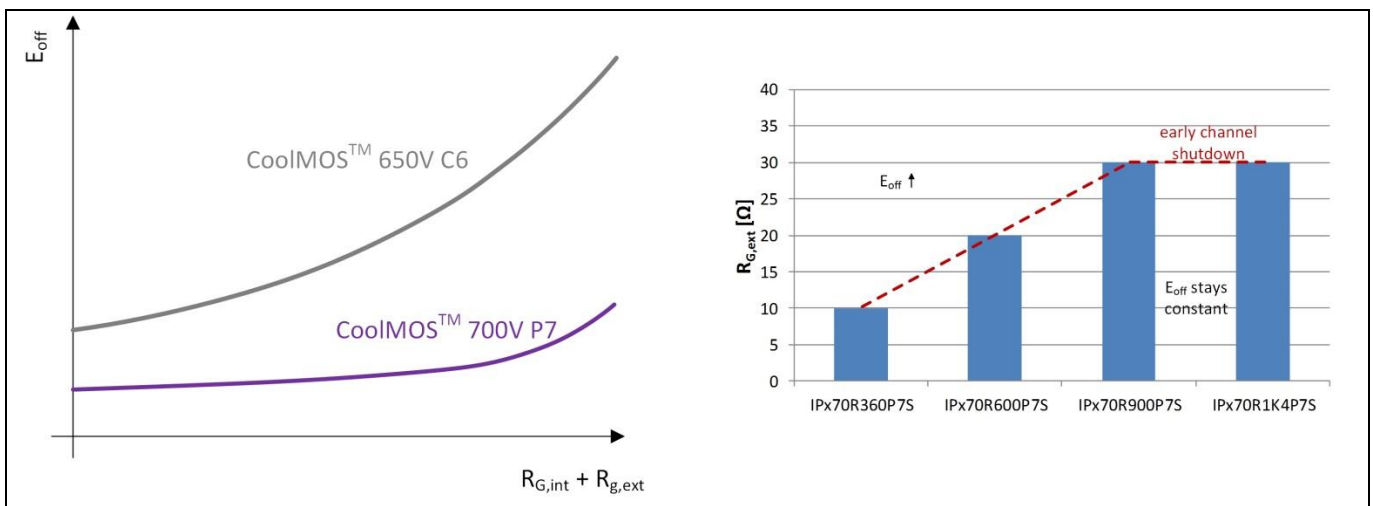

Figure 11 Early channel shutdown 700 V CoolMOS™ P7 (simplified)

Due to this behavior it is possible to properly define the end applications for safety, EMI and efficiency requirements at the same time.

Now that the key technology parameters of the 700 V CoolMOS™ P7 have been described, the next chapter will illustrate real application measurements with respect to thermal performance, efficiency and EMI.

3 Benchmarking of 700 V CoolMOS™ P7 in low power designs

As already anticipated, 700 V CoolMOS™ P7 is tailored for low power applications that use flyback topologies and DCM PFCs. This chapter is intended to show the performance benefits customers can enjoy with 700 V CoolMOS™ P7 in comparison to competitors devices.

3.1 12 W customer charger

The first benchmark will show the efficiency and thermal benefits that can be achieved using 700 V CoolMOS™ P7 in a plug and play scenario while not sacrificing ease of use, especially for radiated electromagnetic interference. This 12 W customer charger is a high end single output quasi resonant flyback battery charger for mobile devices with a switching frequency of up to 140 kHz.

3.1.1 Efficiency / thermals

Typically, designers of charger or adapter applications are interested in the mold compound temperature after 30 min burn-in running at full load, the 75%, 50% and 25% load points and the average efficiency. The following diagram represents the relative efficiency comparison over the output current. The IPS70R1K4P7S is used as a reference.

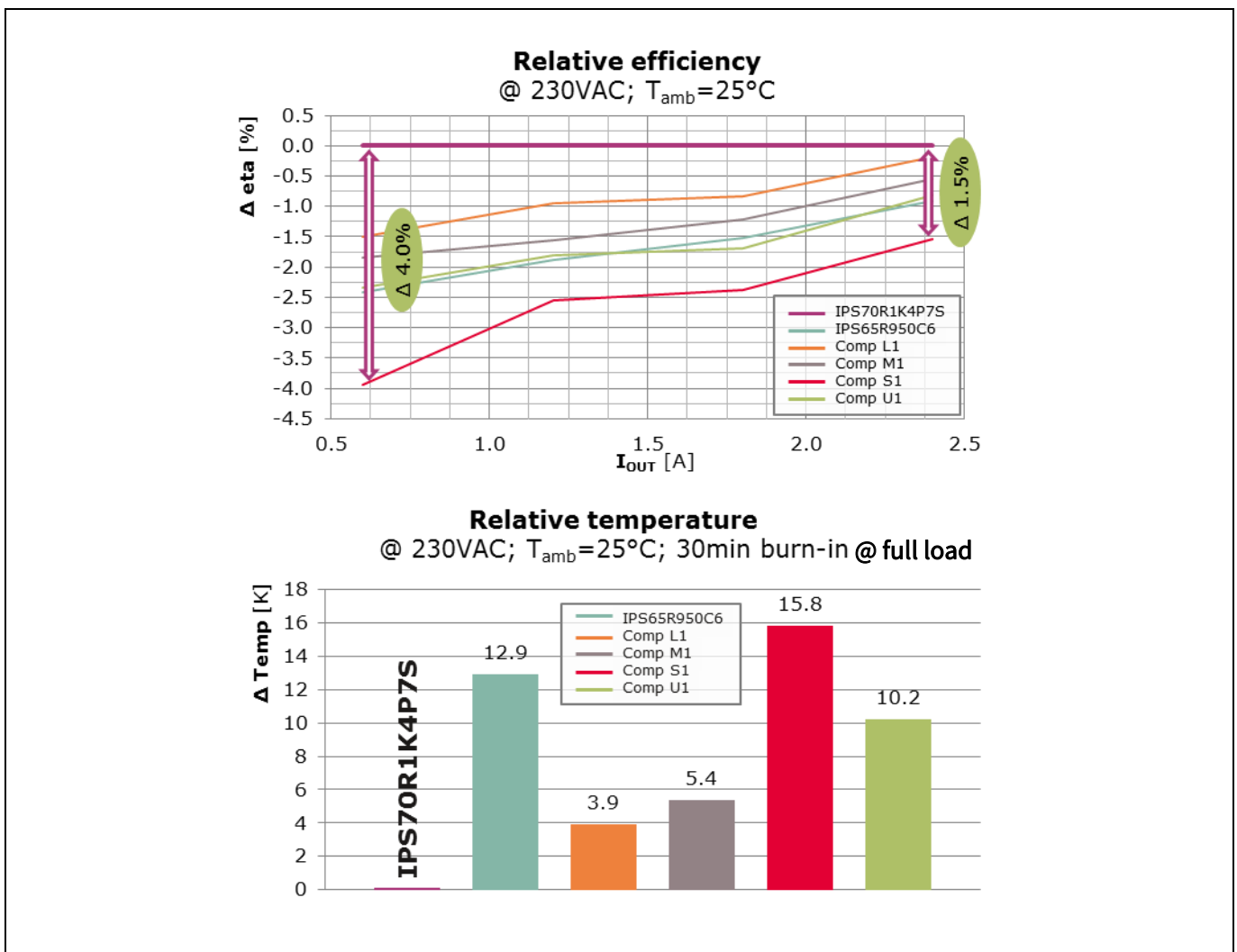

Figure 12 Efficiency and thermal comparison – 12 W customer charger at 25°C ambient and 230 V_{AC} input voltage

700 V CoolMOS™ P7

First 700 V CoolMOS™ MOSFET developed on 300 mm for low power applications

Benchmarking of 700 V CoolMOS™ P7 in low power designs

As can be seen in Figure 12, the new IPS70R1K4P7S outperforms all internal and external competitors that have an $R_{DS(on),max}$ of around 900 mΩ. Especially in light load operation, 700 V CoolMOS™ P7 offers 4% higher efficiency against the competitors of this design. At full load operation and 30 minutes burn in, IPS70R1K4P7S shows the lowest mold compound temperature with ~13°C lower temperature in comparison to competitors and ~16°C lower temperature than 650 V C6.

This benchmarking shows that customers can benefit from higher efficiency and thermal performance with a 1400 mΩ device from 700 V CoolMOS™ P7 compared to 900mΩ devices from competitors. Customers may choose to use the next higher $R_{DS(on)}$ class to save cost. Furthermore, a better thermal performance allows designers to select cost competitive packages as SOT-223.

3.1.2 Radiated EMI

Beside efficiency and thermals, EMI is a very important factor for any charger or adapter application. Figure 13 below shows the maximum quasi-peak values of the radiated field according to EN55022B and also includes the same competitors as included in the previous results. This measurement was performed in a European Union certified EMI chamber.

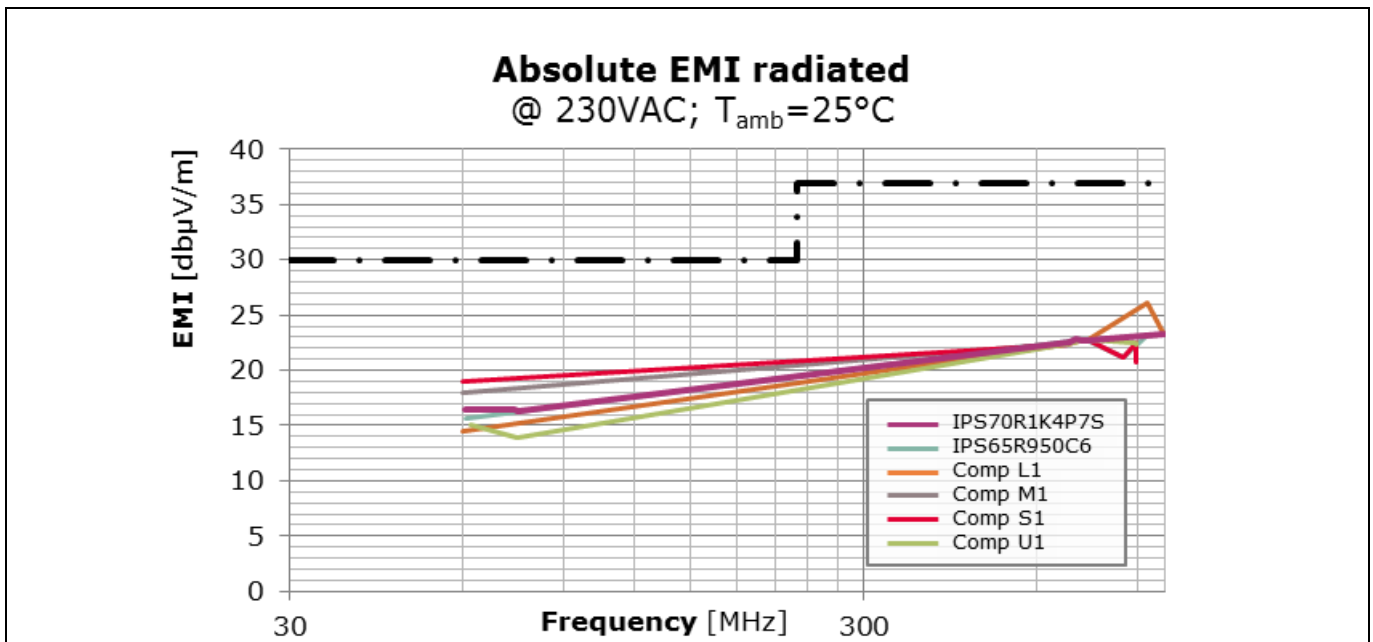

Figure 13 Radiated EMI comparison in 12 W customer charger according to EN55022B

700 V CoolMOS™ P7 exceeds the EMI specifications of EN55022B and shows more than 10 dBuV/m safety margin to the specification limits with $R_{G,ext} = 0 \Omega$ during turn off. This customer charger, even when operating up to 140 kHz, is an excellent design with respect to EMI behavior due to the additional EMI filtering and cancellation windings. All devices have greater than 10dBuV/m margin over the specification limits showing that 700 V CoolMOS™ P7 performs at least as well as all competitors.

3.2 35 W Infineon adapter

This 35 W adapter is a single stage quasi-resonant flyback adapter that demonstrates that it is possible to run in DCM mode for higher power applications while reducing the E_{on} losses to a minimum. Nevertheless, this adapter differs significantly from the 12 W customer charger as it operates between 65 kHz and 80 kHz. This measurement will show that 700 V CoolMOS™ P7 delivers best performance in higher frequency applications but also shows the highest performance in lower frequency applications. It will prove the value of 700 V CoolMOS™ P7 in low to mid frequency ranges.

3.2.1 Efficiency / thermals

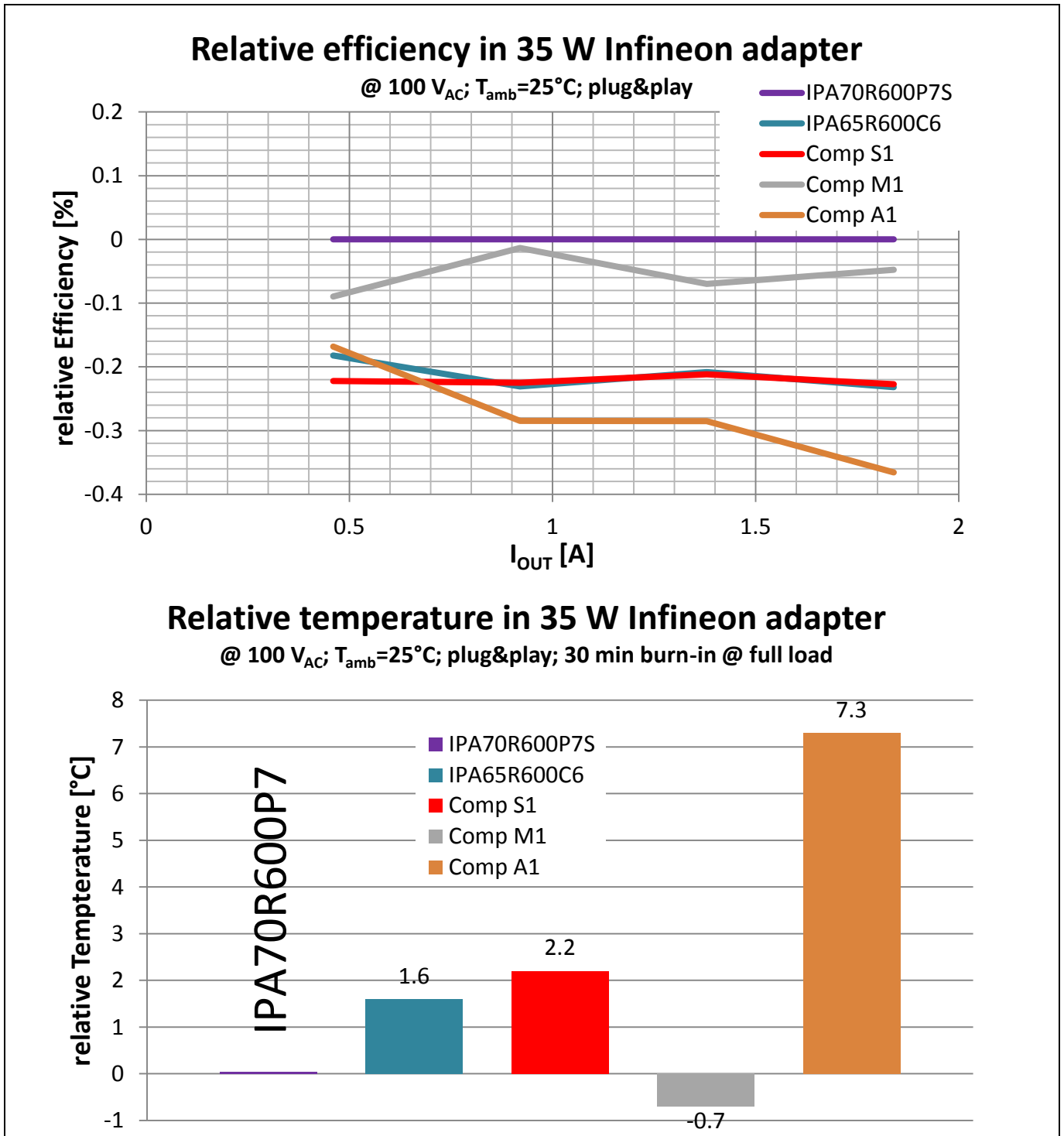

Figure 14 Efficiency and thermal comparison – 35 W Infineon adapter at 25°C ambient and 100 V_{AC} input voltage

This measurement shows that the low to mid frequency performance is not as pronounced as in higher frequency applications. Nevertheless, this analysis also shows that 700 V CoolMOS™ P7 offers higher efficiency and better or equal thermal performance than any other competitor devices. Furthermore, due to the outstanding efficiency in light load conditions, 700 V CoolMOS™ P7 has much higher average efficiency than any competitor device. 700 V CoolMOS™ P7 is therefore the best solution for any new design which might be subject

Benchmarking of 700 V CoolMOS™ P7 in low power designs

to more stringent efficiency regulations in the future. Only Competitor M1 shows a slightly lower mold compound temperature, although only within the measurement tolerance.

3.2.2 Radiated EMI

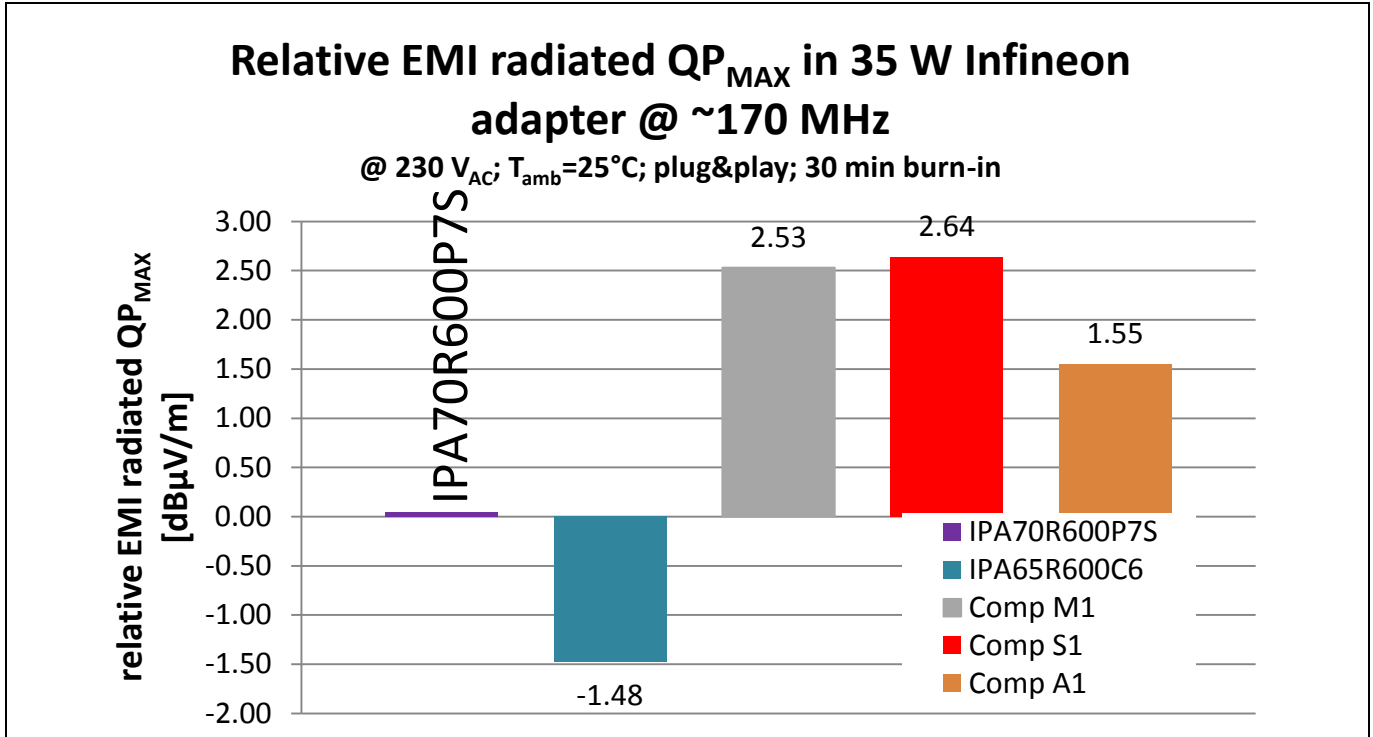

Figure 15 Radiated EMI comparison in 35 W Infineon adapter according to EN55022B

Figure 15 shows that IPA70R600P7S has a smaller maximum quasi-peak value over the whole EN55022B frequency range than that of any other competitor. Only IPA65R600C6 shows a better radiated EMI performance but loses out with respect to efficiency due to higher gate charge and generally higher E_{off}.

3.3 Benchmarking summary (key facts) for all measurements

Customers can benefit due to the ability to change to higher R_{DS(on)} classes thus reducing overall costs.

As was illustrated earlier, 700 V CoolMOS™ P7 is an enabler for higher switching frequency applications in order to reduce the overall magnetic content of the application resulting in a smaller form factor and therefore higher power density.

700 V CoolMOS™ P7 shows its best performance at high line operation due to the E_{oss} behavior but shows also good performance during low line operation due to the temperature dependency of R_{DS(on)}.

700 V CoolMOS™ P7 offers an additional 50 V safety margin for 650 V applications due to the increased break down voltage.

EMI behavior depends on the application itself, but measurements have shown that it is possible to have lower radiated EMI than currently available competitor devices.

4 Portfolio

700 V CoolMOS™ P7 shows a finely graduated portfolio with respect to $R_{DS(on)}$ classes and offers the most relevant packages for low power applications. All main applications are shown including lighting, TV, audio and auxiliary power supply applications.

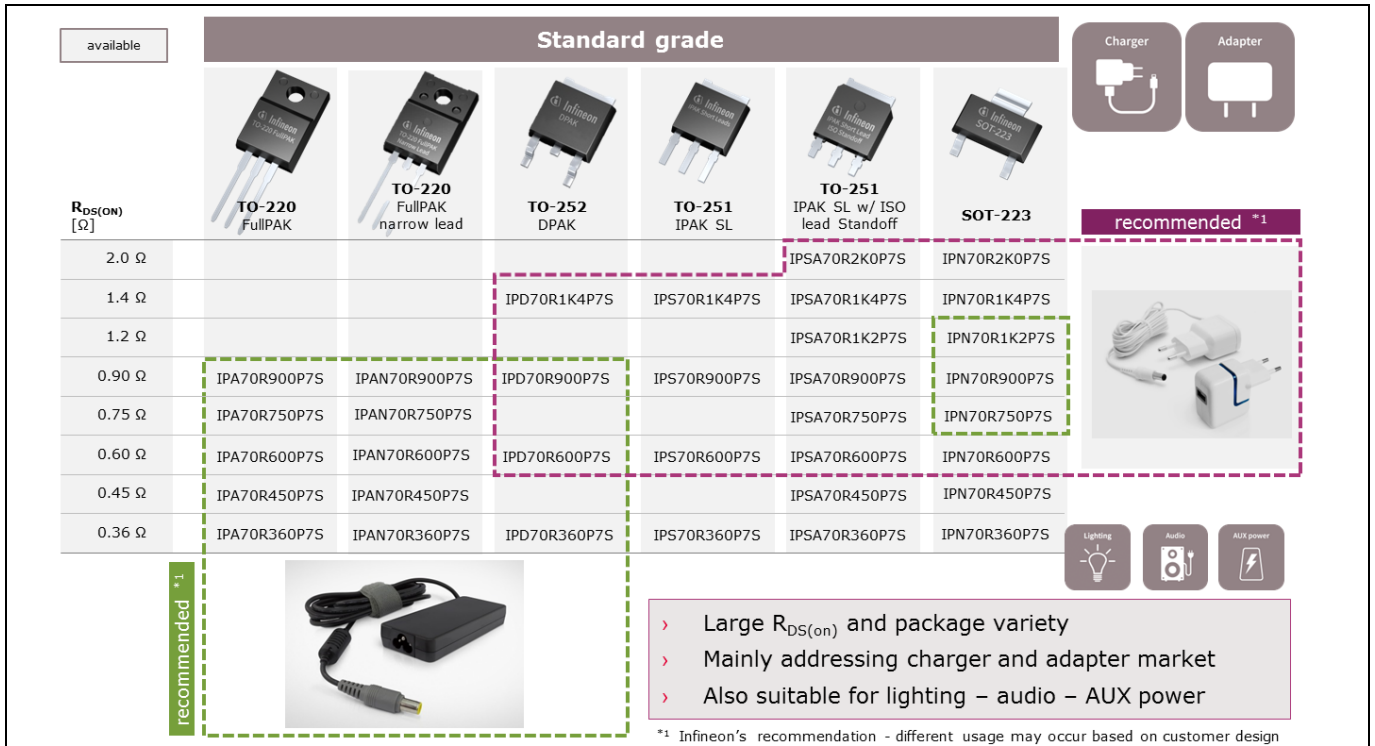

Figure 16 700 V CoolMOS™ P7 portfolio standard grade

Infineon has introduced a new package concept where an IPAK with short leads also includes an isolated lead standoff. This package can reduce arcing problems between the leads caused by solder residues that occur during the soldering process and an imperfect cleaning process. Furthermore, 700 V CoolMOS™ P7 is available in SOT-223 which offers the possibility for a completely automated production process, thus further reducing overall production costs.

Before coming to the final chapter which includes some design recommendations and rules, readers should note that there is a lot of other material for 700 V CoolMOS™ P7 on the web at www.infineon.com/p7.

Demoboards for the 700 V CoolMOS™ P7 are also available so please visit the homepage for more information.

Last but certainly not least, Infineon's experienced CoolMOS™ team offers great support to designers facing challenges with respect to all the topics mentioned in this document (e.g. BOM cost, efficiency, thermals and EMI regulation fulfillment) thus helping our customers to be highly successful in their market.

5 Design considerations

The last chapter will describe the most relevant design considerations.

5.1 Paralleling of MOSFETs

Typically, these applications do not use paralleled MOSFETs, nevertheless in order to parallel MOSFETs a gate ferrite bead is always recommended. Appropriate values depend on the parasitics of the PCB itself.

5.2 Source impedance (source bead)

Source impedances are used in order to slow down the di/dt on the drain path resulting in a lower drain source overvoltage peak. Nevertheless, it also induces a voltage drop during turn on and turn off that can lead to oscillations in the gate drive loop. This influences the general EMI behavior and could also lead to destruction of any MOSFET if this voltage oscillation drives the gate source voltage over +30 V or under -30 V.

Therefore a source bead is not recommended to limit a possible overvoltage peak from drain to source.

5.3 Target applications

700 V CoolMOS™ P7 is not permitted to be used in half or full bridge configurations or any other topology where a hard commutation on a conducting body diode can appear.



Revision history

Major changes since the last revision

Page or Reference	Description of change
P19	Updated product portfolio

Trademarks of Infineon Technologies AG

AURIX™, C166™, CanPAK™, CIPOS™, CoolGaN™, CoolMOS™, CoolSET™, CoolSiC™, CORECONTROL™, CROSSAVE™, DAVE™, DI-POL™, DrBlade™, EasyPIM™, EconoBRIDGE™, EconoDUAL™, EconoPACK™, EconoPIM™, EiceDRIVER™, eupec™, FCOS™, HITFET™, HybridPACK™, Infineon™, ISOFACE™, IsoPACK™, i-Wafer™, MIPAQ™, ModSTACK™, my-d™, NovalithIC™, OmniTune™, OPTIGA™, OptiMOS™, ORIGA™, POWERCODE™, PRIMARION™, PrimePACK™, PrimeSTACK™, PROFET™, PRO-SiL™, RASIC™, REAL3™, ReverSave™, SatRIC™, SIEGET™, SIPMOS™, SmartLEWIS™, SOLID FLASH™, SPOC™, TEMPFET™, thinQ!™, TRENCHSTOP™, TriCore™.

Trademarks updated August 2015

Other Trademarks

All referenced product or service names and trademarks are the property of their respective owners.

Edition 2017-10-13

Published by

Infineon Technologies AG

81726 Munich, Germany

© 2017 Infineon Technologies AG.

All Rights Reserved.

Do you have a question about this document?

Email: erratum@infineon.com

Document reference

AN_201701_PL52_006

IMPORTANT NOTICE

The information contained in this application note is given as a hint for the implementation of the product only and shall in no event be regarded as a description or warranty of a certain functionality, condition or quality of the product. Before implementation of the product, the recipient of this application note must verify any function and other technical information given herein in the real application. Infineon Technologies hereby disclaims any and all warranties and liabilities of any kind (including without limitation warranties of non-infringement of intellectual property rights of any third party) with respect to any and all information given in this application note.

The data contained in this document is exclusively intended for technically trained staff. It is the responsibility of customer's technical departments to evaluate the suitability of the product for the intended application and the completeness of the product information given in this document with respect to such application.

For further information on the product, technology, delivery terms and conditions and prices please contact your nearest Infineon Technologies office (www.infineon.com).

WARNINGS

Due to technical requirements products may contain dangerous substances. For information on the types in question please contact your nearest Infineon Technologies office.

Except as otherwise explicitly approved by Infineon Technologies in a written document signed by authorized representatives of Infineon Technologies, Infineon Technologies' products may not be used in any applications where a failure of the product or any consequences of the use thereof can reasonably be expected to result in personal injury.