



**Please note that Cypress is an Infineon Technologies Company.**

The document following this cover page is marked as “Cypress” document as this is the company that originally developed the product. Please note that Infineon will continue to offer the product to new and existing customers as part of the Infineon product portfolio.

**Continuity of document content**

The fact that Infineon offers the following product as part of the Infineon product portfolio does not lead to any changes to this document. Future revisions will occur when appropriate, and any changes will be set out on the document history page.

**Continuity of ordering part numbers**

Infineon continues to support existing part numbers. Please continue to use the ordering part numbers listed in the datasheet for ordering.



## KitProg2 User Guide

Doc. # 002-10738 Rev. \*K

Cypress Semiconductor  
198 Champion Court  
San Jose, CA 95134-1709  
[www.cypress.com](http://www.cypress.com)

## Copyrights

© Cypress Semiconductor Corporation, 2016–2018. This document is the property of Cypress Semiconductor Corporation and its subsidiaries, including Spansion LLC ("Cypress"). This document, including any software or firmware included or referenced in this document ("Software"), is owned by Cypress under the intellectual property laws and treaties of the United States and other countries worldwide. Cypress reserves all rights under such laws and treaties and does not, except as specifically stated in this paragraph, grant any license under its patents, copyrights, trademarks, or other intellectual property rights. If the Software is not accompanied by a license agreement and you do not otherwise have a written agreement with Cypress governing the use of the Software, then Cypress hereby grants you a personal, non-exclusive, nontransferable license (without the right to sublicense) (1) under its copyright rights in the Software (a) for Software provided in source code form, to modify and reproduce the Software solely for use with Cypress hardware products, only internally within your organization, and (b) to distribute the Software in binary code form externally to end users (either directly or indirectly through resellers and distributors), solely for use on Cypress hardware product units, and (2) under those claims of Cypress's patents that are infringed by the Software (as provided by Cypress, unmodified) to make, use, distribute, and import the Software solely for use with Cypress hardware products. Any other use, reproduction, modification, translation, or compilation of the Software is prohibited.

TO THE EXTENT PERMITTED BY APPLICABLE LAW, CYPRESS MAKES NO WARRANTY OF ANY KIND, EXPRESS OR IMPLIED, WITH REGARD TO THIS DOCUMENT OR ANY SOFTWARE OR ACCOMPANYING HARDWARE, INCLUDING, BUT NOT LIMITED TO, THE IMPLIED WARRANTIES OF MERCHANTABILITY AND FITNESS FOR A PARTICULAR PURPOSE. To the extent permitted by applicable law, Cypress reserves the right to make changes to this document without further notice. Cypress does not assume any liability arising out of the application or use of any product or circuit described in this document. Any information provided in this document, including any sample design information or programming code, is provided only for reference purposes. It is the responsibility of the user of this document to properly design, program, and test the functionality and safety of any application made of this information and any resulting product. Cypress products are not designed, intended, or authorized for use as critical components in systems designed or intended for the operation of weapons, weapons systems, nuclear installations, life-support devices or systems, other medical devices or systems (including resuscitation equipment and surgical implants), pollution control or hazardous substances management, or other uses where the failure of the device or system could cause personal injury, death, or property damage ("Unintended Uses"). A critical component is any component of a device or system whose failure to perform can be reasonably expected to cause the failure of the device or system, or to affect its safety or effectiveness. Cypress is not liable, in whole or in part, and you shall and hereby do release Cypress from any claim, damage, or other liability arising from or related to all Unintended Uses of Cypress products. You shall indemnify and hold Cypress harmless from and against all claims, costs, damages, and other liabilities, including claims for personal injury or death, arising from or related to any Unintended Uses of Cypress products.

Cypress, the Cypress logo, Spansion, the Spansion logo, and combinations thereof, PSoC, CapSense, EZ-USB, F-RAM, PSoC Creator, and Traveo are trademarks or registered trademarks of Cypress in the United States and other countries. For a more complete list of Cypress trademarks, visit [cypress.com](http://cypress.com). Other names and brands may be claimed as property of their respective owners.

# Contents



<b>1. Introduction</b>	<b>5</b>
1.1 Switching between KitProg2 Modes .....	7
1.2 Acronyms .....	9
<b>2. Ecosystem</b>	<b>10</b>
<b>3. KitProg2 Mode Programmer and Debugger</b>	<b>12</b>
3.1 KitProg2 Driver Installation .....	12
3.2 Programming Using PSoC Creator .....	13
3.3 Debugging Using PSoC Creator .....	16
3.4 Programming Using PSoC Programmer .....	17
3.5 Updating the KitProg2 Firmware .....	17
<b>4. CMSIS-DAP Mode Programming and Debugging</b>	<b>20</b>
4.1 Programming and Debugging using $\mu$ Vision .....	20
<b>5. Mass Storage Programmer</b>	<b>27</b>
5.1 Enter or Exit the Mass Storage Programmer Mode .....	27
5.2 Programming Using the Mass Storage Programmer .....	27
5.3 Frequently Asked Questions on KitProg2 Mass Storage Programmer .....	29
<b>6. USB-UART Bridge</b>	<b>30</b>
<b>7. USB-I2C Bridge</b>	<b>41</b>
<b>8. USB-SPI Bridge</b>	<b>52</b>
<b>9. Developing Applications for PSoC 5LP</b>	<b>58</b>
9.1 Building a Custom Bootloadable Application for KitProg2 .....	58
9.2 Building a Normal Project for PSoC 5LP .....	67
<b>10. Troubleshooting the KitProg2</b>	<b>71</b>
10.1 KitProg2 Status LED Indication .....	71
10.2 PSoC 5LP Factory Program Restore Instructions .....	73
10.2.1 PSoC 5LP is Programmed with a Custom Application .....	73
10.2.1.1 Restore PSoC 5LP Factory Program Using PSoC Programmer .....	74
10.2.2 Restore PSoC 5LP KitProg2 using MiniProg3 .....	76

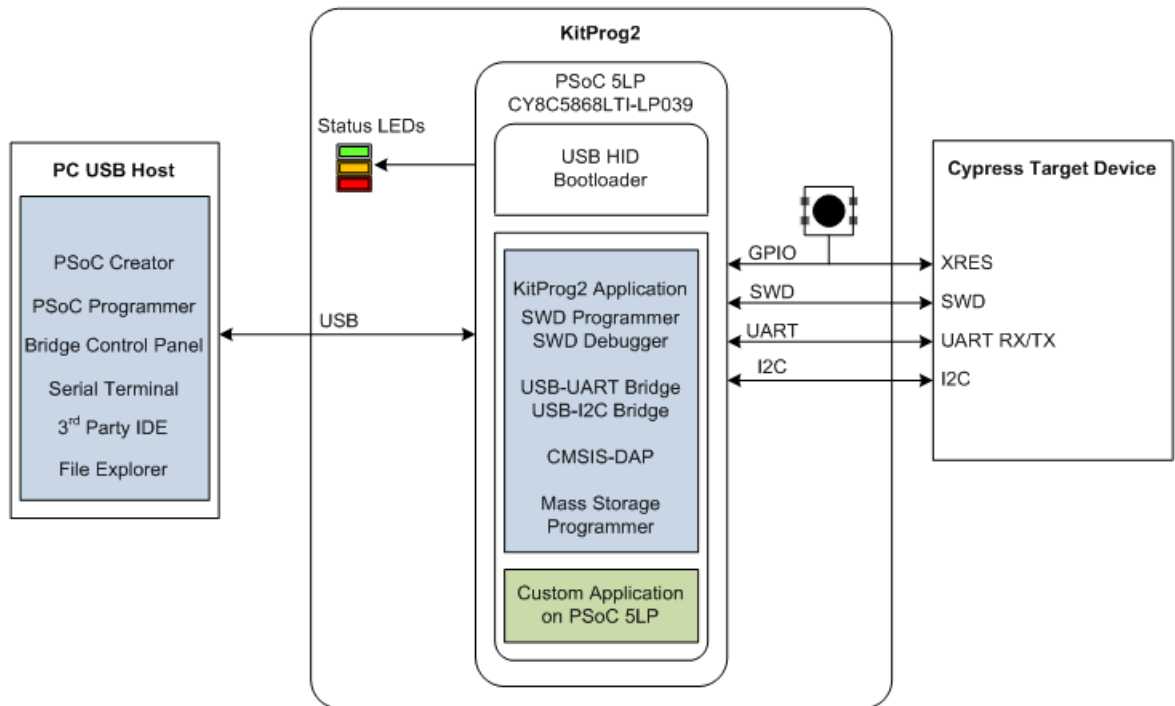
<b>A. Appendix</b>	<b>78</b>
A.1 Pin Assignments .....	78
A.1.1 PSoC 5LP GPIO and Custom Application Header (J8 and J11) for CY8CKIT-041-40XX and CY8CKIT-041-41XX .....	78
A.1.2 PSoC 5LP GPIO and Custom Application Header (J16 and J11) for CY8CKIT-048.....	79
A.1.3 PSoC 5LP GPIO and Custom Application Header (J6 and J7) for CY8CKIT-145-40XX.....	79
 <b>Revision History</b>	 <b>80</b>

# 1. Introduction



The KitProg2 is an onboard programmer/debugger with USB-UART, USB-I2C and USB-SPI Bridge functionality. It is an update to the existing KitProg used for programming and debugging the target device. The KitProg2 is integrated onto most PSoC<sup>®</sup> development kits. This user guide provides comprehensive information on how to use the KitProg2 with PSoC development kits. [Figure 1-1](#) shows the KitProg2 ecosystem. The Cypress PSoC 5LP device is used to implement the KitProg2 functionality.

Figure 1-1. KitProg2 Ecosystem



KitProg2 is an enhancement over KitProg. It follows the dual-image bootloading approach; the KitProg2 firmware is the first image and a custom application can be loaded as a second image. To learn more about the concept of dual-image bootloading, refer to application note [AN73854 – PSoC 3, PSoC 4, and PSoC 5LP Introduction to Bootloaders](#).

Figure 1-2. KitProg2 Dual-Image Bootloader Architecture

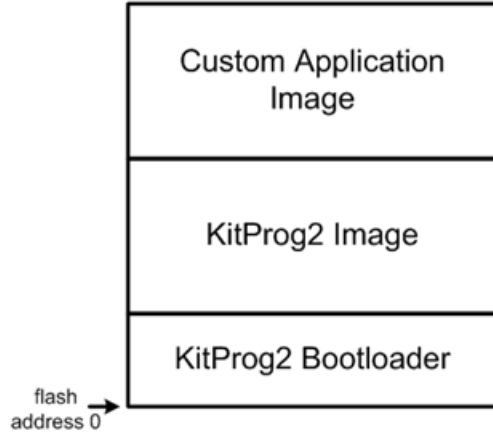


Figure 1-2 shows the KitProg2 flash architecture based on the concept of dual-image bootloading. If you are building custom applications for PSoC 5LP in KitProg2, only the ‘Custom Application Image’ flash area can be bootloaded with the corresponding *cyacd* file. The KitProg2 image cannot be bootloaded. It can only be restored to factory settings as described in [Restore PSoC 5LP Factory Program Using PSoC Programmer on page 74](#).

The KitProg2 image contains SWD, CMSIS-DAP, and Mass Storage Programmer functionality to program a target PSoC, and USB-UART/USB-I2C/USB-SPI Bridge functionality. The custom application image can be any application that PSoC 5LP can execute. To create custom applications, refer to the [Developing Applications for PSoC 5LP chapter on page 58](#).

## 1.1 Switching between KitProg2 Modes

There are three types of kits that use KitProg2 programmers. These are: (1) prototyping kits (also known as stamp boards) which have a single mode switch and a single amber status LED; (2) development kits (also known as pioneer kits) which have a single mode switch and 3 status LEDs; and (3) development kits which have two mode switches and three status LEDs.

Figure 1-3 shows how to switch between modes in KitProg2. Part (a) of Figure 1-3 is valid for all kits with a single mode switch. This figure illustrates the switching workflow using the CY8CKIT-041-40XX kit as an example, which has SW3 as the mode switch. Part (b) of Figure 1-3 is valid for all kits with dual mode switches. This figure illustrates the switching workflow using the CY8CKIT-062 BLE Pioneer Kit. In either case the input on the mode switch or switches is evaluated; depending on the current mode of operation, the next mode of operation is ascertained.

On power-on reset or reset, PSoC 5LP enters bootloader entry mode. If the mode switch SW3 was pressed while the USB connector was plugged in and then released, KitProg2 enters bootloader mode. If the mode switch SW3 was not pressed, then depending on the current mode of operation, PSoC 5LP will enter PPCOM mode, Mass Storage Programming/CMSIS-DAP mode, or the custom application.

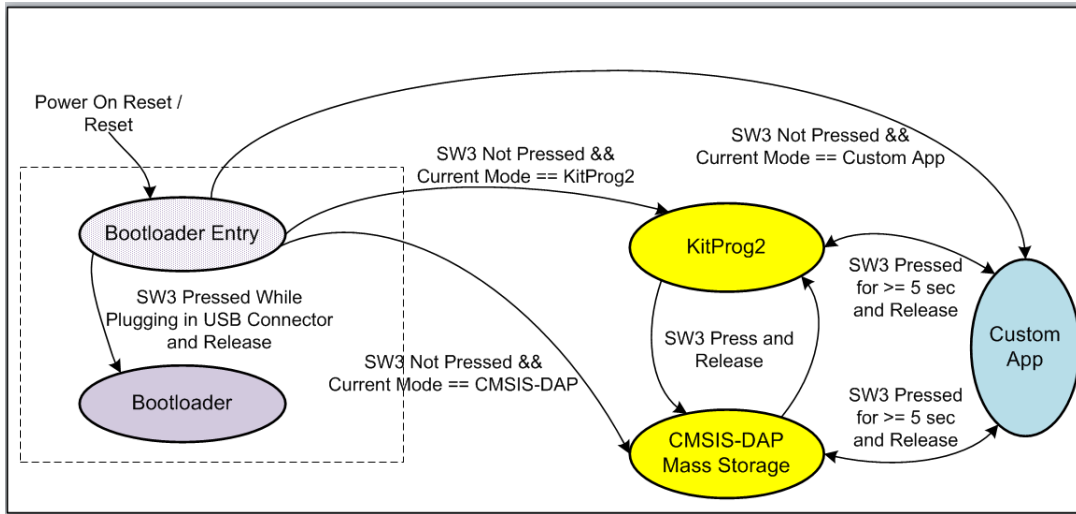
As illustrated in Figure 1-3 part (a) switching between KitProg2 and Mass Storage Programming/CMSIS-DAP mode can be achieved by pressing and releasing the mode switch within five seconds. Similarly, switching to the custom application from the PPCOM or Mass Storage Programming/CMSIS-DAP mode can be achieved by pressing and holding the mode switch for more than five seconds and then releasing. Switching from the custom mode back to PPCOM or Mass Storage Programming/CMSIS-DAP modes is dependent on the custom application implementation.

In order to recognize the various state changes the Amber LED shows different effects. When in KitProg2 Mode the Amber LED lights up, when in Mass Storage/CMSIS-DAP mode the Amber LED turns off and when in bootloader mode the Amber LED shows a blinking effect.

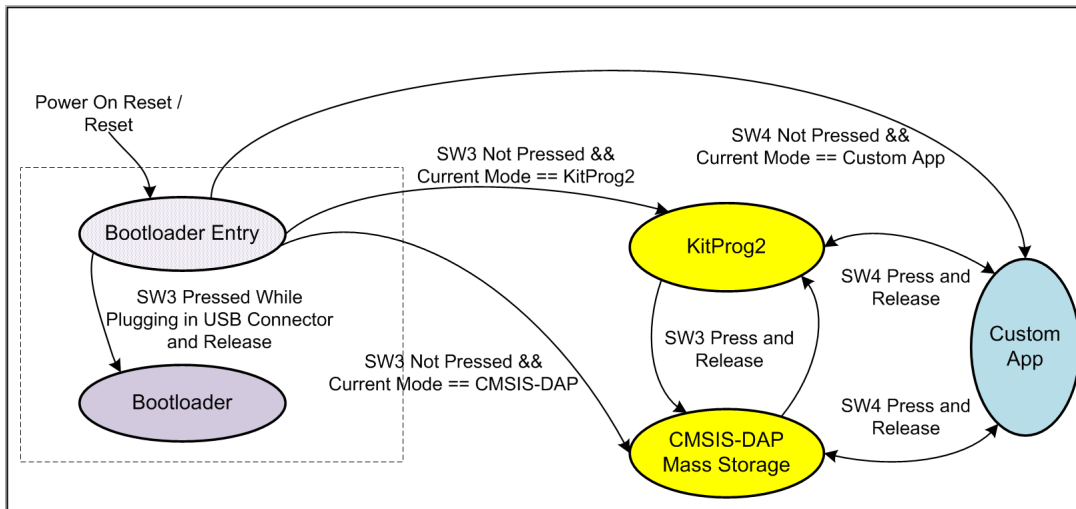


Figure 1-3. Switching between KitProg2 Modes

a) For Single Mode Switch Development Kits



b) For Two Mode Switch Development Kits



**Note:** In order to switch back from custom mode application to CMSIS-DAP/Mass Storage or KitProg2 within the firmware, refer [Developing Applications for PSoC 5LP on page 58](#).

**Note:** After pressing and releasing the mode switch, it may take a few seconds for the kit to re-enumerate in the new mode. While enumeration is taking place, none of the status LEDs will be ON.

## 1.2 Acronyms

Acronym	Definition
BCP	Bridge Control Panel
BLE	Bluetooth Low Energy
CMSIS-DAP	Cortex Microcontroller Software Interface Standard Debug Access Protocol
GPIO	General-Purpose Input/Output
HID	Human Interface Device
I2C	Inter-Integrated Circuit
IDE	Integrated Development Environment
JTAG	Joint Test Action Group
LED	Light-Emitting Diode
MISO	Master-In-Serial-Out
MOSI	Master-Out-Serial-In
NVL	Non Volatile Latch
PC	Personal Computer
PPCOM	PSoC Programmer Component Object Module
PSoC	Programmable System-on-Chip
RAM	Random Access Memory
ROM	Read-Only Memory
SCB	Serial Communication Block
SCL	Serial Clock Line
SDA	Serial Data Line
SPI	Serial Peripheral Interface
SWD	Serial Wire Debug
UART	Universal Asynchronous Receiver Transmitter
UDB	Universal Digital Block
USB	Universal Serial Bus
XRES	External Reset

## 2. Ecosystem



Table 2-1 lists the development kits that use the KitProg2. Table 2-2 lists the prerequisite Cypress software needed to use the KitProg2.

Table 2-1. Development Kits Supported by KitProg2

Development Kits	Target Device	KitProg2 onboard mode switches
CY8CKIT-041-40XX PSoC 4 S-Series Pioneer Kit	PSoC 4000S	Single Switch
CY8CKIT-041-41XX PSoC 4100S Pioneer Kit	PSoC 4100S	Single Switch
CY8CKIT-048 PSoC Analog Coprocessor Pioneer Kit	PSoC Analog Coprocessor	Single Switch
CY8CKIT-145-40XX PSoC 4 S-Series Prototyping Kit	PSoC 4000S	Single Switch
CY8CKIT-146 PSoC 4200DS Prototyping Kit	PSoC 4200DS	Single Switch
CY8CKIT-147 PSoC 4100PS Prototyping Kit	PSoC 4100PS	Single Switch
CY8CKIT-148 PSoC 4700S Inductive Sensing Evaluation Kit	PSoC 4700S	Single Switch
CY8CKIT-149 PSoC 4100S Plus Prototyping Kit	PSoC 4100S Plus	Single Switch
CY8CPROTO-063-BLE PSoC 6 BLE Prototyping Kit	PSoC 6 MCU (PSoC 63 Line)	Single Switch
CY8CKIT-062-BLE PSoC 6 BLE Pioneer Kit	PSoC 6 MCU (PSoC 63 Line)	Dual Switch
CY8CKIT-062-WiFi-BT PSoC 6 WiFi-BT Pioneer Kit	PSoC 6 MCU (PSoC 62 Line)	Dual Switch

Table 2-2. Prerequisite Software for KitProg2 Operation

Functionality	Pre-requisite Software	Download Link/Remarks
Programmer	PSoC Programmer	<a href="http://www.cypress.com/psocprogrammer">www.cypress.com/psocprogrammer</a>
Debugger	PSoC Creator	<a href="http://www.cypress.com/psoccreator">www.cypress.com/psoccreator</a>
USB-I2C Bridge	Bridge Control Panel (BCP)	Installed along with PSoC Programmer
USB-SPI Bridge	Bridge Control Panel (BCP)	Installed along with PSoC Programmer
USB-UART Bridge	Terminal Emulator Program	Any terminal emulator program can be used such as HyperTerminal (available as part of Microsoft Windows XP installation) or PuTTY (available on <a href="http://www.putty.org">www.putty.org</a> )

KitProg2 supports different speeds for communication interfaces. [Table 2-3](#) summarizes the KitProg2 operating modes.

Table 2-3. KitProg2 Operating Modes

Functionality	Supported Speed	Units
Programmer	1.6	MHz
USB-UART Bridge	1200, 2400, 4800, 9600, 19200, 38400, 57600, and 115200	Baud
USB-I2C Bridge	50, 100, 400, 1000	kHz
USB-SPI Bridge	50–6000	kHz

This document assumes that you know the basics of using PSoC Creator™. If you are new to PSoC Creator, refer to the documentation in the [PSoC Creator home page](#). You can also refer to the following application notes to get started with PSoC devices:

- [Getting Started with PSoC® 4](#)
- [Getting Started with PSoC® 4 BLE](#)
- [Getting Started with PSoC® 5LP](#)
- [Getting Started with CapSense®](#)

## 3. KitProg2 Mode Programmer and Debugger



This section explains how the KitProg2 programmer/debugger is integrated onto the PSoC development kits. The KitProg2 supports the development kits listed in [Table 2-1 on page 10](#). This section uses the PSoC 4 S-Series Pioneer Kit as an example.

KitProg2 uses two types of programming/debugging interfaces – PPCOM and CMSIS-DAP. The PPCOM interface supports Cypress tool chains such as PSoC Creator and PSoC Programmer. The PPCOM interface provides additional options such as programming NVLs, which are not available via a standard CMSIS-DAP interface.

CMSIS-DAP is an alternative programming/debugging interface in which the KitProg2 can be used with third-party tool chains to program/debug the target. This mode is selected when you press and release the mode switch for less than two seconds.

The amber status LED stays ON if the KitProg2 is in PPCOM interface mode and it turns off at a rate of 1 Hz if the KitProg2 is in CMSIS-DAP/Mass Storage Programming mode.

Refer to [Switching between KitProg2 Modes on page 7](#) to understand the behavior of the status LED.

**Note:** PPCOM is the abbreviation for PSoC Programmer Component Object Module. It is the programming/debugging interface provided in Cypress' PSoC Creator and PSoC Programmer.

### 3.1 KitProg2 Driver Installation

The kit is powered from a computer over the USB interface. It enumerates as a composite device. The USB drivers required for enumeration are part of the kit installer and should be appropriately installed for correct operation.

[Figure 3-1](#) shows the driver installation in PPCOM programming mode and [Figure 3-2](#) shows the driver installation in CMSIS-DAP programming mode.

Figure 3-1. KitProg2 Driver Installation in PPCOM Programming Mode

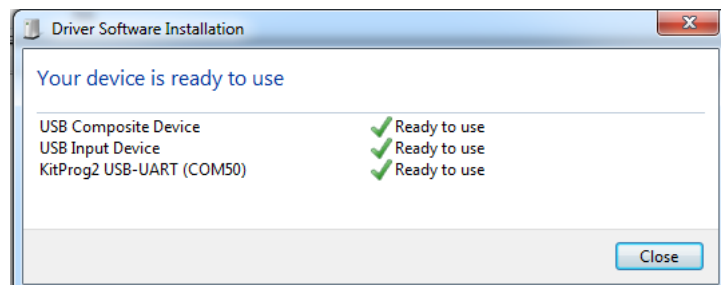
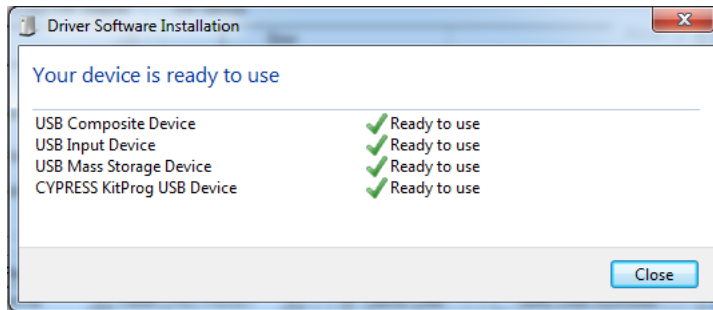


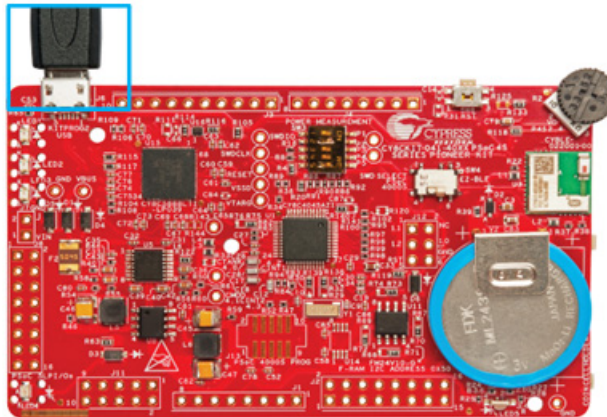
Figure 3-2. KitProg2 Driver Installation in CMSIS-DAP Programming Mode



## 3.2 Programming Using PSoC Creator

1. Connect a USB cable to the USB connector, J6, as shown in [Figure 3-3](#). If you are connecting the kit to your PC for the first time, it enumerates as a USB composite device and installs the required driver software.
2. Verify the KitProg2 is in PPCOM mode (Amber LED is ON). See [Switching between KitProg2 Modes](#) on [page 7](#) for details.

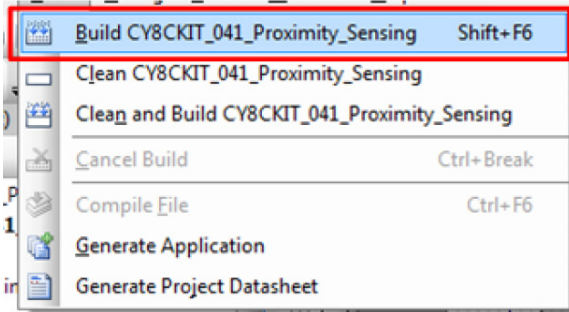
Figure 3-3. Connect USB Cable to J6 (Pioneer Kits)



3. Launch PSoC Creator from **Start > All Programs > Cypress > PSoC Creator <version> > PSoC Creator <version>**.
4. Select **File > Open > Project/Workspace** in PSoC Creator and browse to the desired project. You may also select **File > Code Example** to browse through a library of existing example projects. See [PSoC Creator User Guide](#) for details.

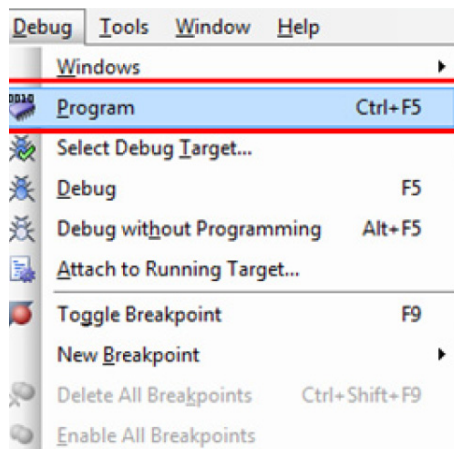
5. Select **Build > Build Project** or press **[Shift] [F6]** to build the project, as shown in [Figure 3-4](#).

Figure 3-4. Build an Example Project



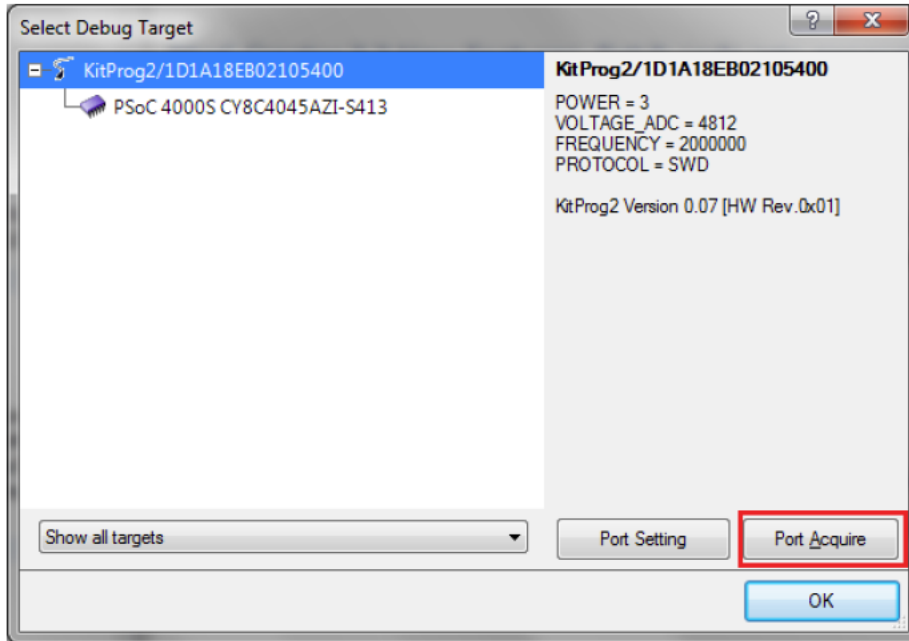
6. If there are no errors during build, program the PSoC 4000S device on the kit by choosing **Debug > Program** or pressing **[Ctrl] [F5]**, as shown in [Figure 3-5](#).

Figure 3-5. Programming Device from PSoC Creator



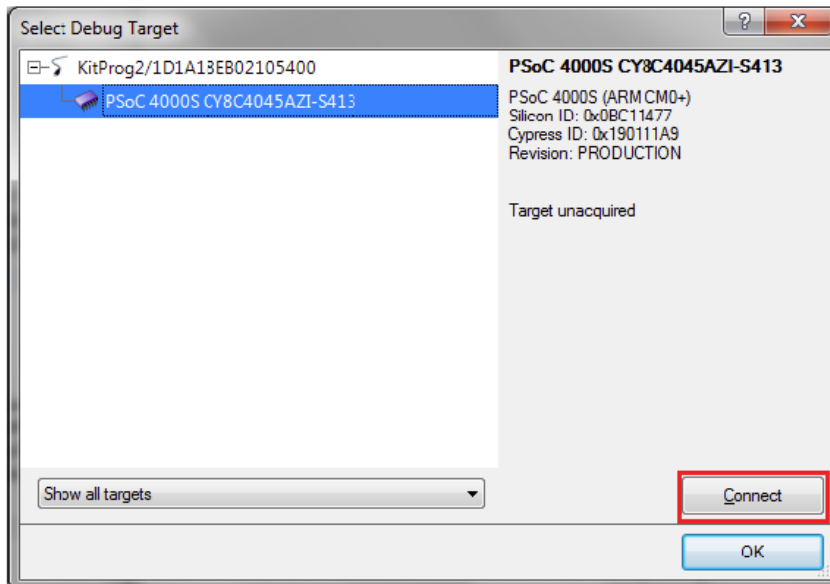
- If the device is already acquired, programming will complete automatically – the result will appear in the PSoC Creator status bar at the bottom left of the screen. If the device is yet to be acquired, the Select Debug Target window will appear. Select **KitProg2/<serial number>** and click the **Port Acquire** button, as shown in [Figure 3-6](#).

Figure 3-6. Port Acquire



- After the device is acquired, it is shown in a tree structure below the **KitProg2/<serial number>**. Click the **Connect** button and then **OK** to exit the window and start programming, as shown in [Figure 3-7](#).

Figure 3-7. Connect Device from PSoC Creator and Program



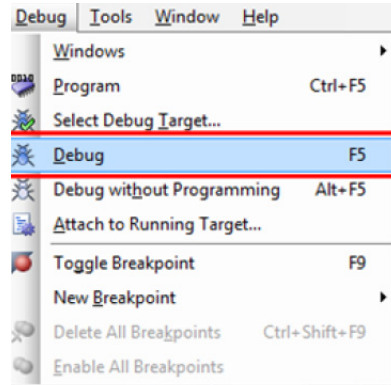


### 3.3 Debugging Using PSoC Creator

To debug the project using PSoC Creator, follow steps 1 to 5 from section [Programming Using PSoC Creator](#) on page 13. Then, follow these steps:

1. Click the **Debug** icon or press **[F5]**, as shown in [Figure 3-8](#). Alternatively, you can select **Debug > Debug**. This programs the device and starts the debugger.

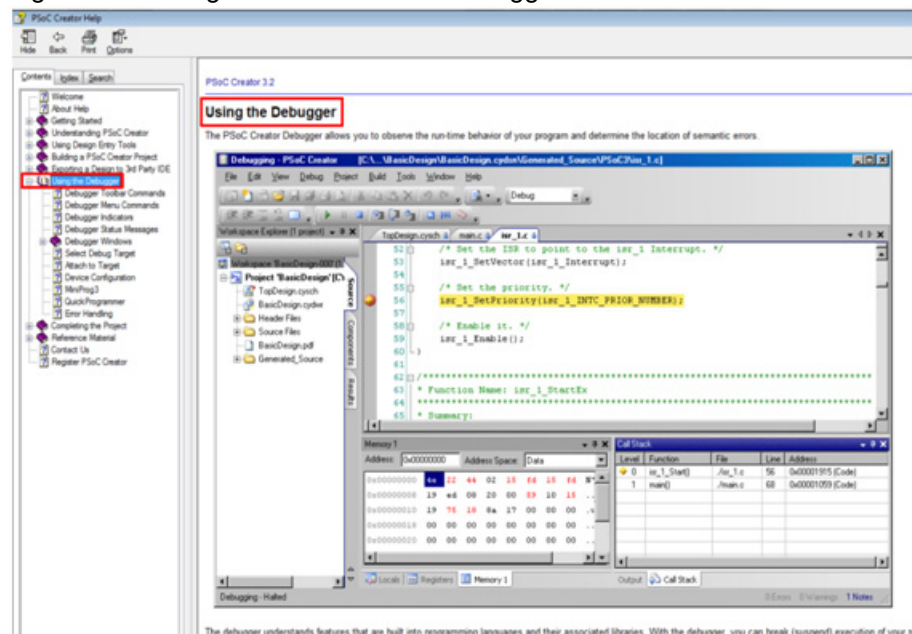
Figure 3-8. Debug Option in PSoC Creator



2. When PSoC Creator enters the Debug mode, use the buttons on the toolbar or keyboard shortcuts to debug your project.

For more details on using the debug features, refer to the PSoC Creator Help. Select **Help > PSoC Creator Help Topics** in the PSoC Creator menu. In the PSoC Creator Help window, locate **Using the Debugger** section in the **Contents** tab, as shown in [Figure 3-9](#).

Figure 3-9. Using the PSoC Creator Debugger



## 3.4 Programming Using PSoC Programmer

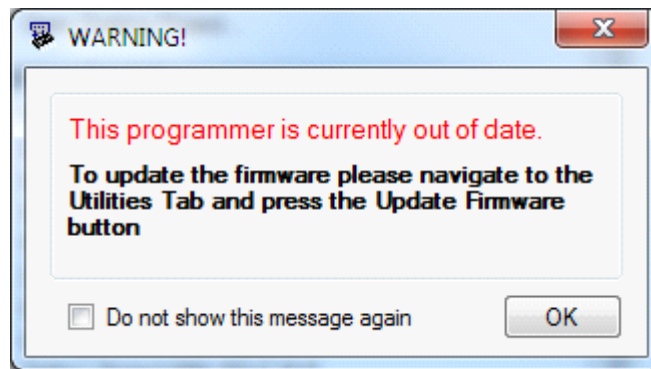
PSoC Programmer (3.24.2 or later) can be used to program existing *.hex* files into the kit. To do this, follow these steps.

1. Connect the kit to your PC and open PSoC Programmer from **Start > All Programs > Cypress > PSoC Programmer <version> > PSoC Programmer <version>**.
2. Click the **File Load** button at the top left corner of the window. Browse to the desired *.hex* file and click **Open**. For PSoC 4000S devices, the *.hex* file is located at:  
`<Project Directory>\<Project Name.cydsn>\CortexM0p\<Compiler Name and Version>\<Debug> or <Release>\<Project Name.hex>`.
3. Click the **KitProg2/<serial number>** in the **Port Selection** list to connect the kit to your computer.
4. Click the **Program** button to start programming the kit with the selected file.  
**Note:** If the *.hex* file does not match the selected device, PSoC Programmer will display a device mismatch error and terminate programming. Ensure that you have selected the correct *.hex* file.
5. When programming is completed successfully, indicated by a PASS message on the status bar, the kit is ready for use. Close PSoC Programmer.

## 3.5 Updating the KitProg2 Firmware

The KitProg2 firmware generally does not require any update. If an update is required, then PSoC Programmer will display a warning message when the kit is connected to it, as shown in [Figure 3-10](#).

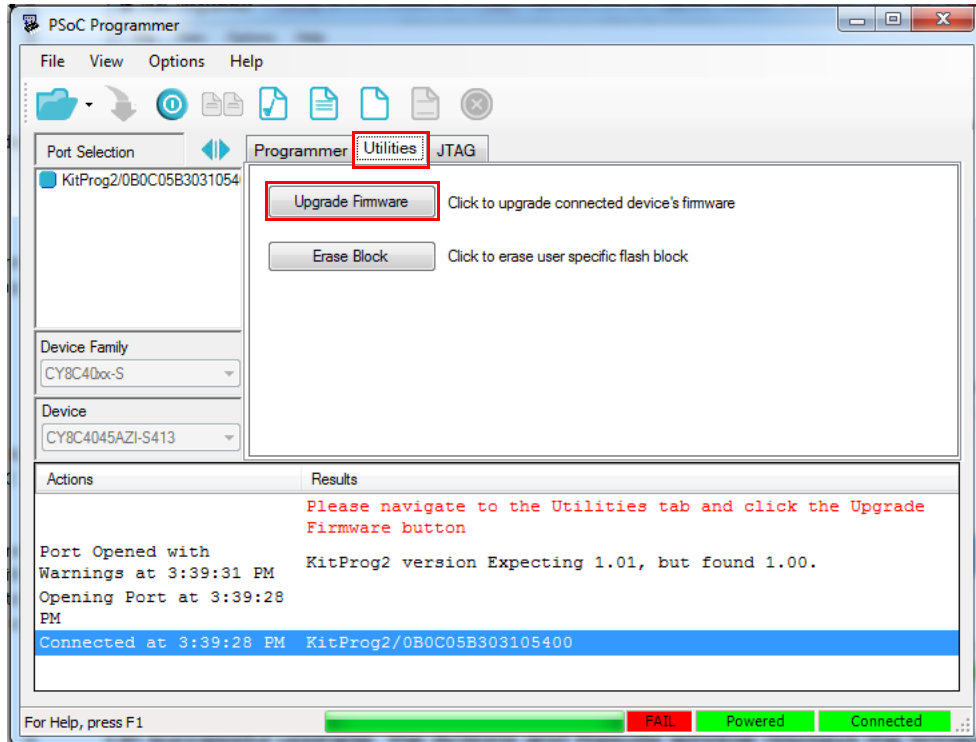
Figure 3-10. KitProg2 Firmware Update Warning



Click **OK** to close the window. On closing the warning window, the Actions and Results window displays: “Please navigate to the Utilities tab and click the Upgrade Firmware button”, as shown in [Figure 3-11](#).

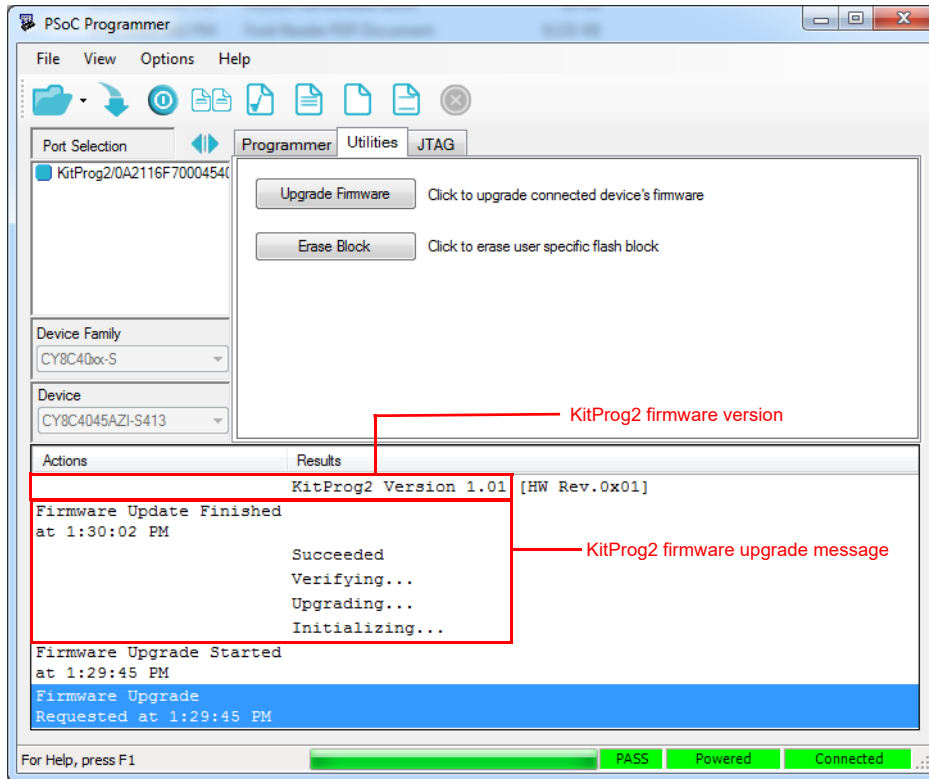
To update the KitProg2, go to the **Utilities** tab on PSoC Programmer and click **Upgrade Firmware**, as shown in [Figure 3-11](#).

Figure 3-11. Upgrade Firmware in PSoC Programmer



On successful upgrade, the Actions and Results window displays the firmware update message with the KitProg2 version, as shown in Figure 3-12.

Figure 3-12. Firmware Updated in PSoC Programmer



## 4. CMSIS-DAP Mode Programming and Debugging



This section explains how the CMSIS-DAP programmer/debugger is integrated onto the PSoC development kits. The KitProg2 supports the development kits listed in [Table 2-1](#). This section uses the PSoC 4 S-Series Pioneer Kit as an example.

The KitProg2 programmer and debugger (PPCOM), KitProg2 USB-I2C Bridge, and KitProg2 USB-UART Bridge functionalities are not available in this configuration.

CMSIS-DAP is an alternative programming/debugging interface in which the KitProg2 can be used with third-party tool chains to program/debug the target. This mode is selected when you press and release the mode switch for less than two seconds.

The amber status LED stays ON if the KitProg2 is in PPCOM interface mode and it turns off at a rate of 1 Hz if the KitProg2 is in CMSIS-DAP/Mass Storage Programming mode.

Refer to [Switching between KitProg2 Modes on page 7](#) to understand the behavior of status LED.

### 4.1 Programming and Debugging using $\mu$ Vision

CMSIS-DAP mode can be used for programming from many third party IDEs. As an example, the steps to program using  $\mu$ Vision are shown below.

To use KitProg2 in CMSIS-DAP mode to program using  $\mu$ Vision, do the following:

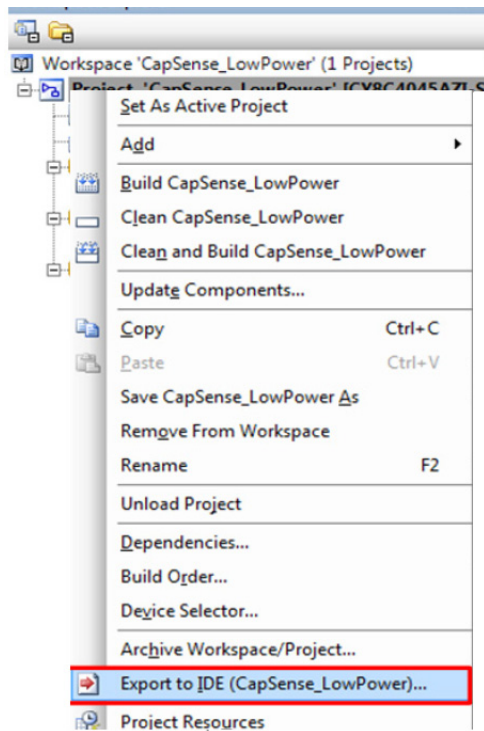
1. Connect the kit to PC and enter into CMSIS-DAP mode. To enter into CMSIS-DAP mode, refer [Switching between KitProg2 Modes on page 7](#).

**Note:** The KitProg2 should be in the CMSIS-DAP programming mode (press mode switch SW3 on CY8CKIT-041-40XX for less than two seconds to change modes). In this mode, the amber LED switches OFF.

**Note:** in KitProg2 1.04 version, this LED will show breathing effect in Mass Storage or CMSIS-DAP mode.

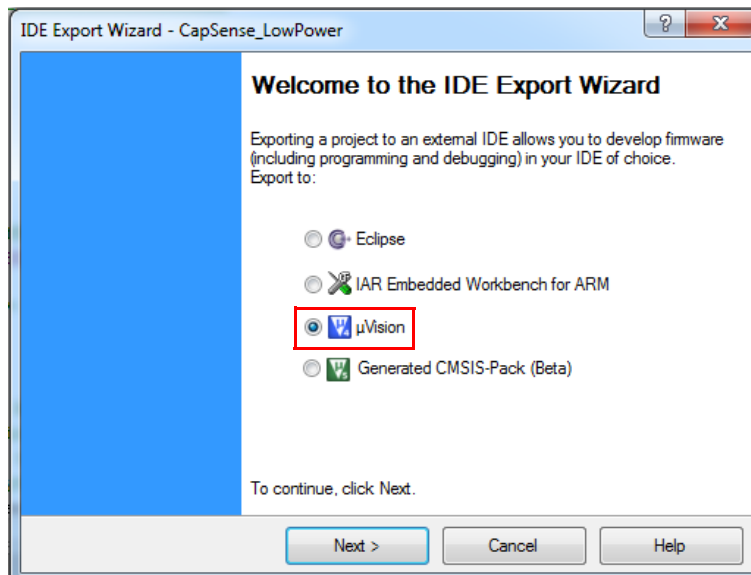
2. Open the project in PSoC Creator and build the project. Right-click the project in the Workspace Explorer and select **Export to IDE**, as shown in [Figure 4-1](#).

Figure 4-1. Export to IDE



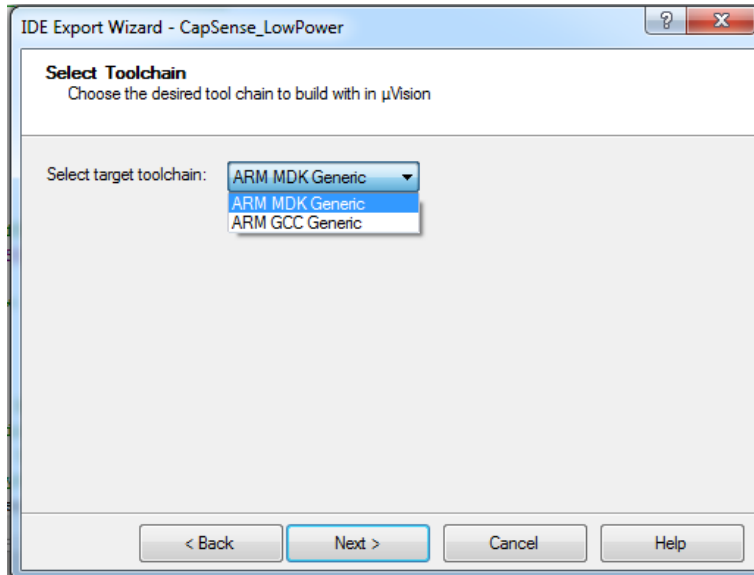
3. Select the IDE as shown in [Figure 4-2](#).

Figure 4-2. Select IDE



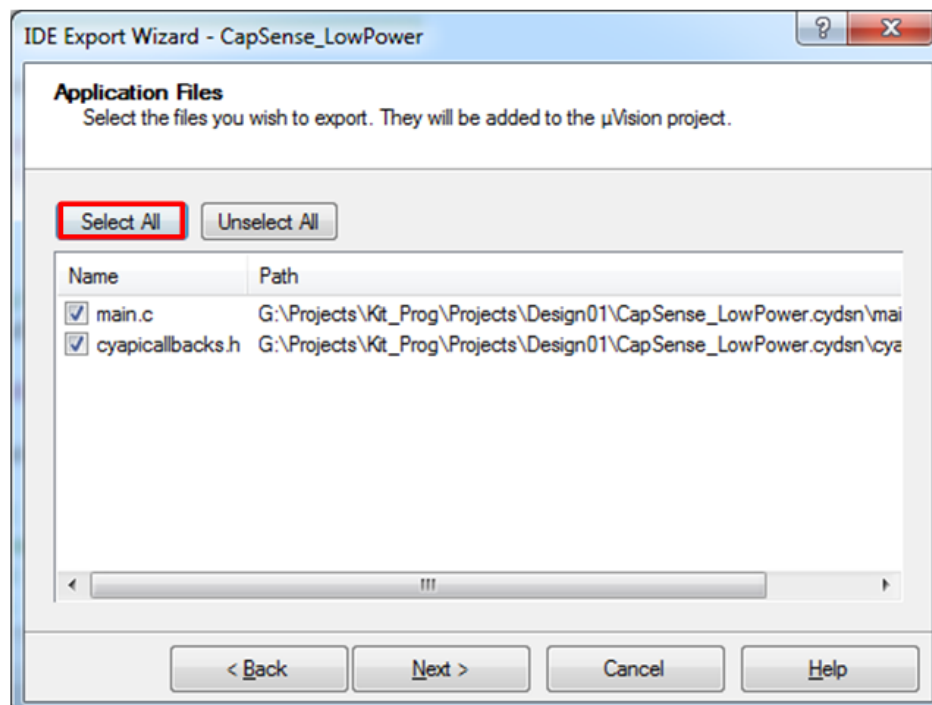
4. Select the tool chain as shown in [Figure 4-3](#).

Figure 4-3. Select Tool Chain



5. Select the project files as shown in [Figure 4-4](#). The next window that appears is **Review export details**. Click **Export**.

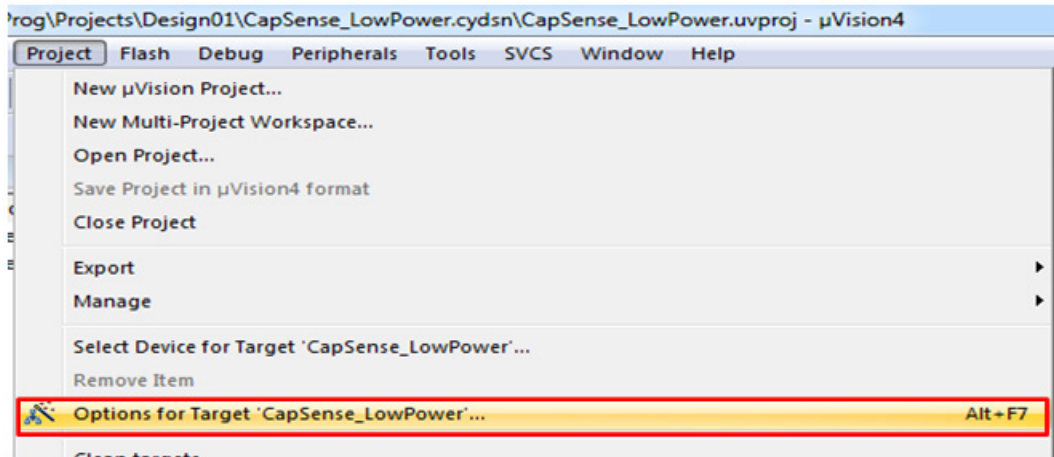
Figure 4-4. Select Project Files



6. Open the  $\mu$ Vision project in the  $\mu$ Vision IDE tool. Keil  $\mu$ Vision version 4.74.0.22 is used in this illustration. Build the project in  $\mu$ Vision.

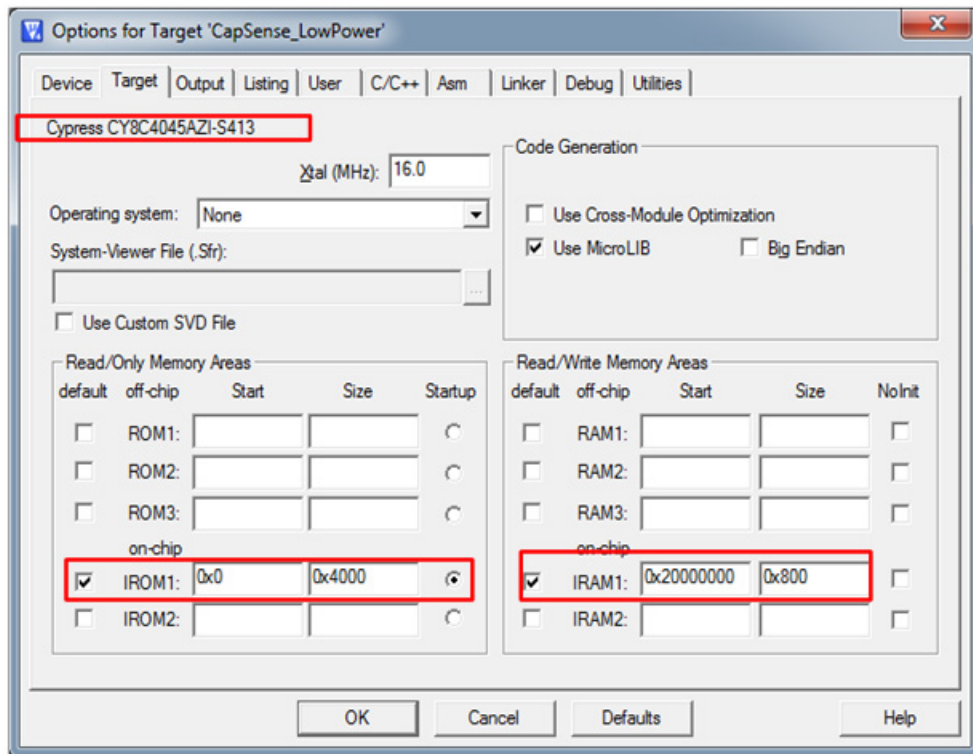
7. Open the PSoC Programmer installation folder and look for the path  
 Programmer\3rd\_Party\_Configuration\_Files\CY8C40xx\Prog\_Algorithm.  
**Note:** The default path location of PSoC programmer installation folder is  
 C:\Program Files (x86)\Cypress\Programmer.
8. Copy the *CY8C40xx.FLM* file to the \ARM\Flash folder inside the installation directory of Keil  
 μVision. This will typically look similar to: C:\Keil\ARM\Flash\
9. Select **Project > Options for Target “project\_name”**.

Figure 4-5. Option for Target in μVision



10. Make sure to set appropriate values for ROM and RAM areas of the target device as shown in  
 Figure 4-6.

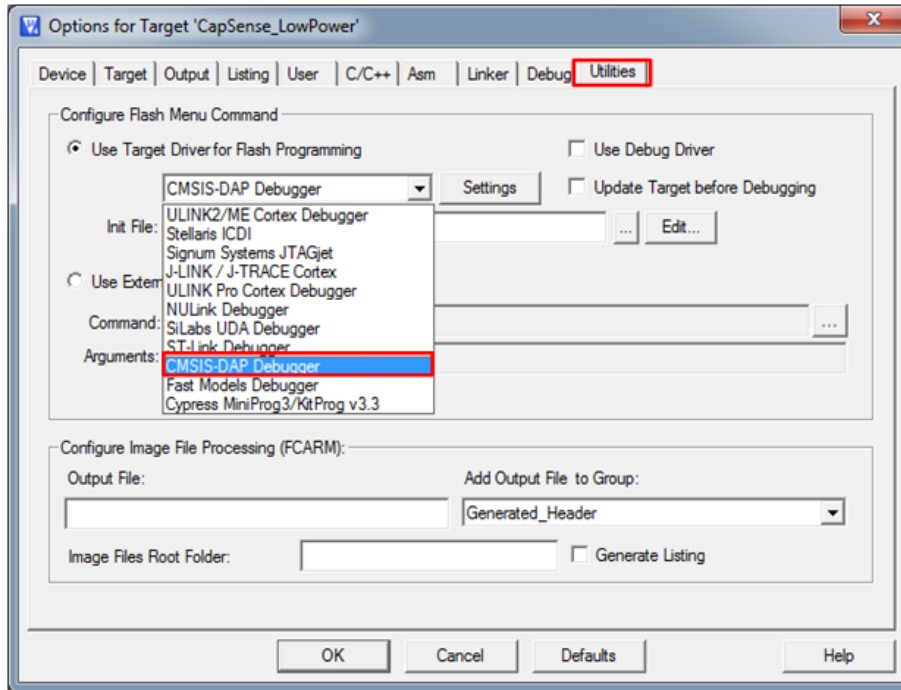
Figure 4-6. Target Tab





11. Select the **Utilities** tab and select **CMSIS-DAP Debugger**, as shown in [Figure 4-7](#).

Figure 4-7. Utilities Tab in  $\mu$ Vision.



12. A programming algorithm must be added in the IDE to program PSoC 4. Click the **Settings** option. The **Cortex-M Target Driver Setup** window will open as shown in [Figure 4-8](#). Go to the **Flash Download** tab and click the **Add** button as shown in [Figure 4-9](#). Select the option corresponding to PSoC 4 in the programming algorithm.

Figure 4-8. Cortex-M Target Driver Setup

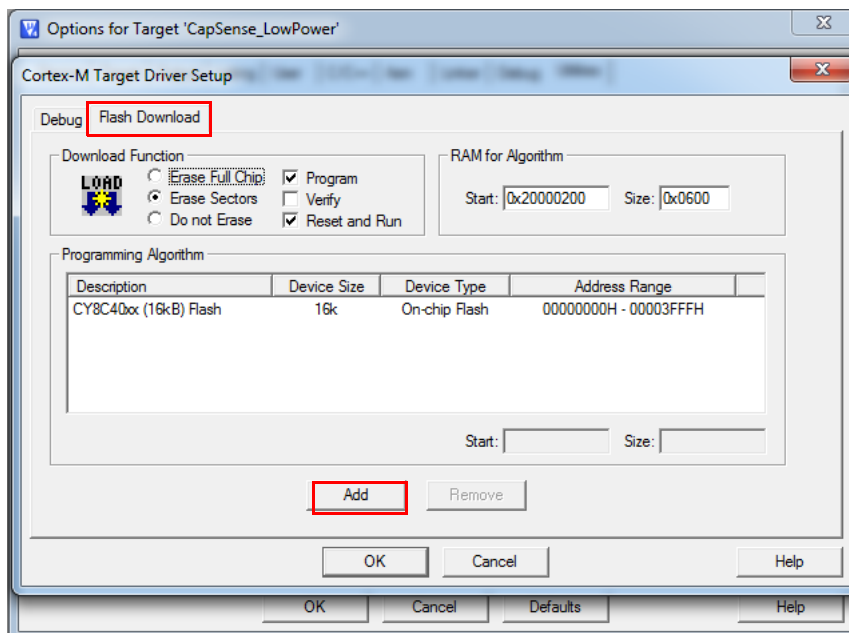
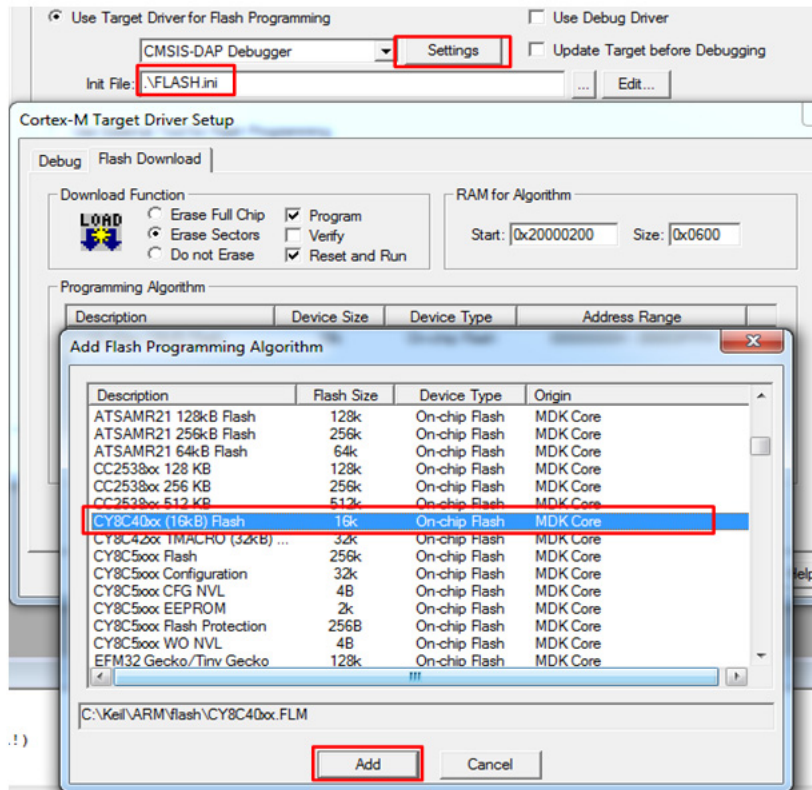
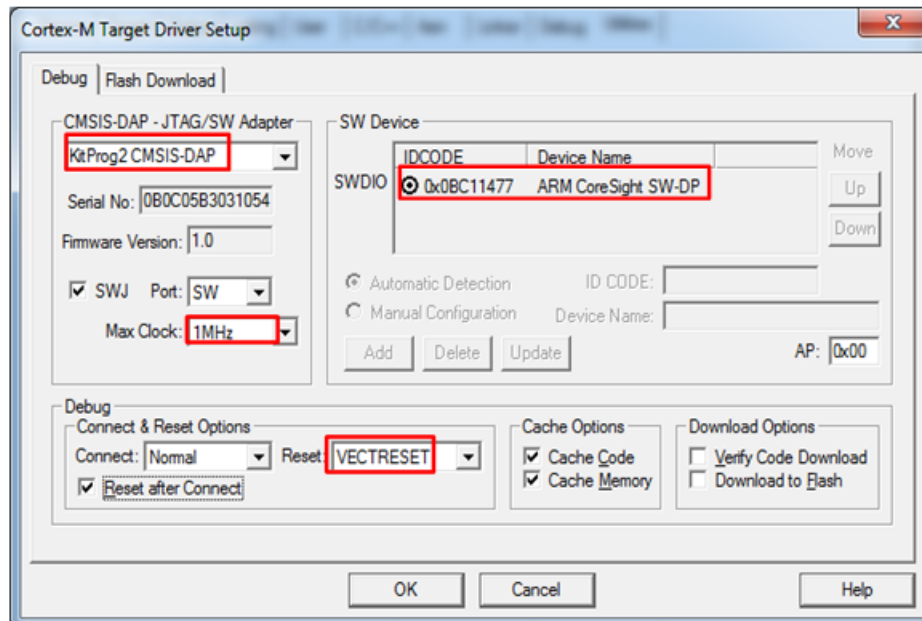


Figure 4-9. Flash Download Tab in Target Driver Setup



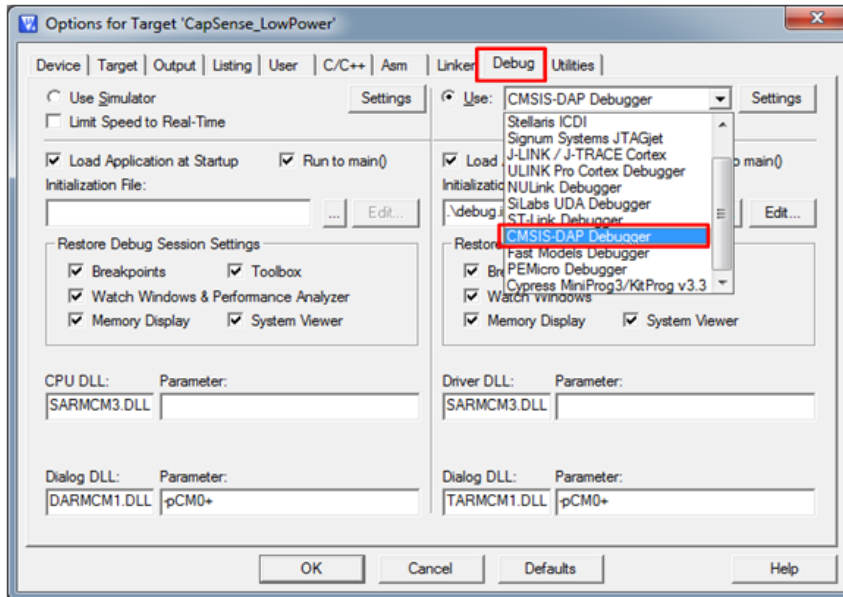
13. Select the **Debug** tab. Make sure that KitProg2 is listed in the CMSIS-DAP – JTAG/SW adapter. Select the port as **SW**; the SW Device field will show **IDcode** as **0x0BB11477**. Set the clock frequency to **1MHz** and the Reset option to **VECTRESET** as shown in Figure 4-10. Click **OK** and program the device using the option **Flash > Download**.

Figure 4-10. Debug Tab in Target Driver Setup



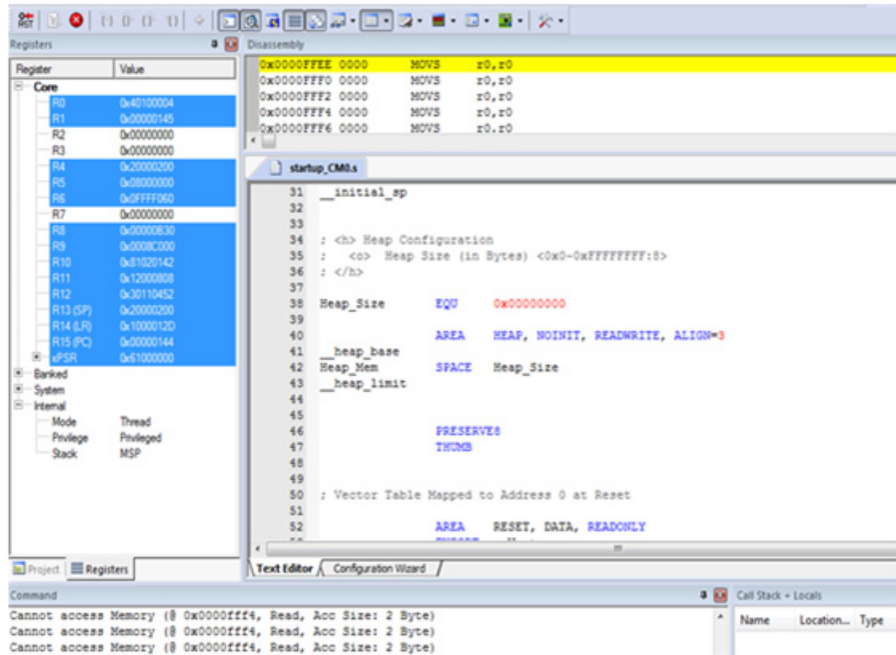
14. For debugging, go to the **Debug** tab and select the CMSIS-DAP Debugger as shown in Figure 4-11.

Figure 4-11. Debug Tab in Options for Target



15. Selecting **Debug > Start/Stop Debug Session** will start the debug session. Note that the green LED on the CY8CKIT-041-40XX blinks at an 8-Hz rate during the debug session.

Figure 4-12. Debug Session in uVision



# 5. Mass Storage Programmer



The KitProg2 can act as a USB Mass Storage Programmer. CMSIS-DAP and Mass Storage modes are the same modes though the method of programming is different. This is an alternative configuration of KitProg2. The KitProg2 programmer and debugger (PPCOM), KitProg2 USB-I2C Bridge, KitProg2 USB-SPI Bridge, and KitProg2 USB-UART Bridge functionalities are not available in this configuration.

## 5.1 Enter or Exit the Mass Storage Programmer Mode

Follow these steps to enter or exit the Mass Storage Programmer mode of KitProg2:

1. Connect the kit to the PC. Ensure that the amber status LED is ON and not blinking. See section [10.1 KitProg2 Status LED Indication on page 71](#) for details on the status LED indications. Amber status LED ON indicates that the current configuration is KitProg2 Programmer and Debugger.
2. Press and release the mode switch within two seconds. The KitProg2 re-enumerates as a Mass Storage Programmer/CMSIS-DAP programmer if the previous configuration is PPCOM programmer and debugger. The amber status LED stops glowing indicating that the kit is in Mass Storage Programming/CMSIS-DAP programming mode.
3. The KitProg2 remains in the selected mode until you change the mode manually using the mode switch. To exit the Mass Storage Programming mode, press and release the mode switch within two seconds. The amber status LED is continuously ON, indicating that the KitProg2 is in the KitProg2 Programmer and Debugger mode.

## 5.2 Programming Using the Mass Storage Programmer

Follow these steps to program the target device using the Mass Storage Programmer:

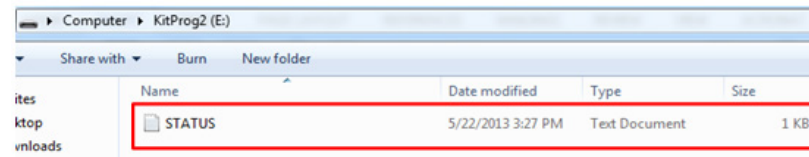
1. Enter the Mass Storage Programmer mode as explained in [Enter or Exit the Mass Storage Programmer Mode on page 27](#). The KitProg2 is visible as a removable disk drive in the file explorer of the PC, as shown in [Figure 5-1](#).

Figure 5-1. KitProg2 Emulated as Mass Storage Device



- Open the KitProg2 drive to view the *STATUS.TXT* file, as shown in [Figure 5-2](#). Note that the file extension *.TXT* is visible for the file only if it is enabled in your PC settings. The *STATUS.TXT* file shows the current status of the Mass Storage Programmer.

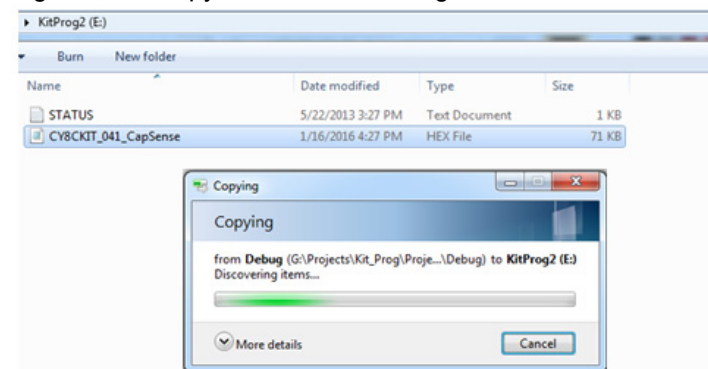
Figure 5-2. *STATUS.TXT* in the KitProg2 Drive



- Copy any PSoC 4000S device based project *.hex* file to the KitProg2 drive to begin programming. Alternatively, you can drag and drop the *.hex* file onto the drive. The *.hex* file for a PSoC Creator project is available in the following path:

`<Project Directory>\<Project Name.cydsn>\CortexM0p\<Compiler Name and Version>\<Debug> or <Release>\<Project Name.hex>`

Figure 5-3. Copy *.hex* File to KitProg2 Drive

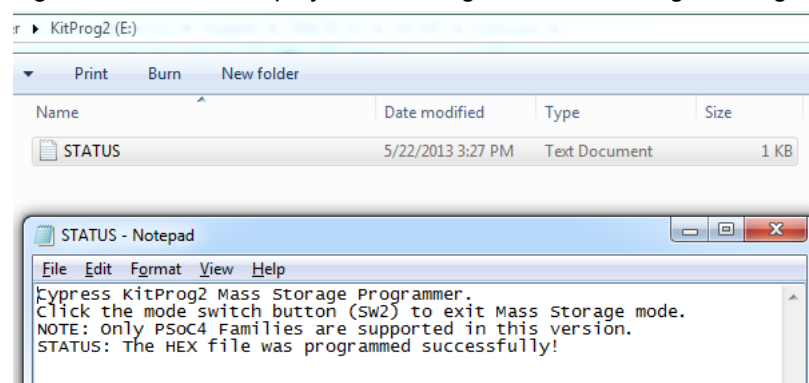


- The green status LED on the kit blinks during the programming operation. It stays ON after the programming operation completes successfully and the KitProg2 drive automatically removes the copied file from the drive. Press **[F5]** in the file explorer to refresh the contents of the drive. This will display only the *STATUS.TXT* file in the KitProg2 drive.

**Note:** For prototyping kits the amber LED blinks during the programming in Mass Storage mode. For more information on switching of modes in prototyping kits, refer [Switching between KitProg2 Modes on page 7](#).

- Open the *STATUS.TXT* file to view the status of the programming operation, as shown in [Figure 5-4](#).

Figure 5-4. Status Displayed in KitProg2 Drive after Programming



## 5.3 Frequently Asked Questions on KitProg2 Mass Storage Programmer

1. What are the Cypress kits supported by the KitProg2 Mass Storage Programmer?  
The KitProg2 Mass Storage Programmer supports all the kits mentioned in [Table 2-1 on page 10](#).  
**Note:** Newer kits which are not listed in the table can be explored in Cypress website <http://www.cypress.com>.
2. What are the operating systems supported by KitProg2 Mass Storage Programmer?  
The KitProg2 Mass Storage Programmer works on Microsoft Windows (XP or later) and Apple Mac operating systems (OSX or later). The KitProg2 Mass Storage Programmer is currently not supported on Linux operating systems.
3. What happens if I copy an incorrect *.hex* file to the KitProg2 drive?  
If you copy a *.hex* file with invalid data (such as incorrect silicon ID and incorrect checksum), the KitProg2 Mass Storage Programmer attempts a programming operation and generates an error indicating which step of the programming operation has failed in the *STATUS.TXT* file.  
If you copy a *.hex* file which corresponds to any other device, the KitProg2 Mass Storage Programmer does not attempt a programming operation and generates an error indicating that the copied file is not a valid *.hex* file in the *STATUS.TXT* file.  
If you copy any file other than the ones specified above, and the file size does not exceed the KitProg2 drive size, the file will be visible in the KitProg2 drive until the drive is removed from the PC. Note that the file is not actually copied to the KitProg2 drive. Delete these files before attempting to program a new *.hex* file.
4. Why does my operating system display the “Disk Not Ejected Properly” pop-up after every programming operation in KitProg2 Mass Storage Programmer mode?  
The KitProg2 Mass Storage Programmer temporarily ejects two seconds after the programming operation. This can also cause the file explorer window of the KitProg2 drive to close after programming operation in some operating systems.
5. Is it possible to program an external PSoC other than the one on the kit using the KitProg2 Mass Storage Programmer?  
Yes. You need to remove several onboard zero-ohm resistors to disconnect the onboard target device. See the documentation for the kit that you are using for details.
6. Can I use *.hex* files generated by any other IDE other than PSoC Creator to program the PSoC 4000S using KitProg2 Mass Storage Programmer?  
Yes. You can use the *.hex* file generated by an external IDE such as Eclipse, IAR, or Keil  $\mu$ Vision which supports PSoC 4 devices, to program using the KitProg2 Mass Storage Programmer.
7. Why does the programming time for different files vary?  
The KitProg2 Mass Storage Programmer intelligently programs only the flash rows with non-zero data. Depending on the contents of your project, the programming time may take up to 30 seconds.



## 6. USB-UART Bridge

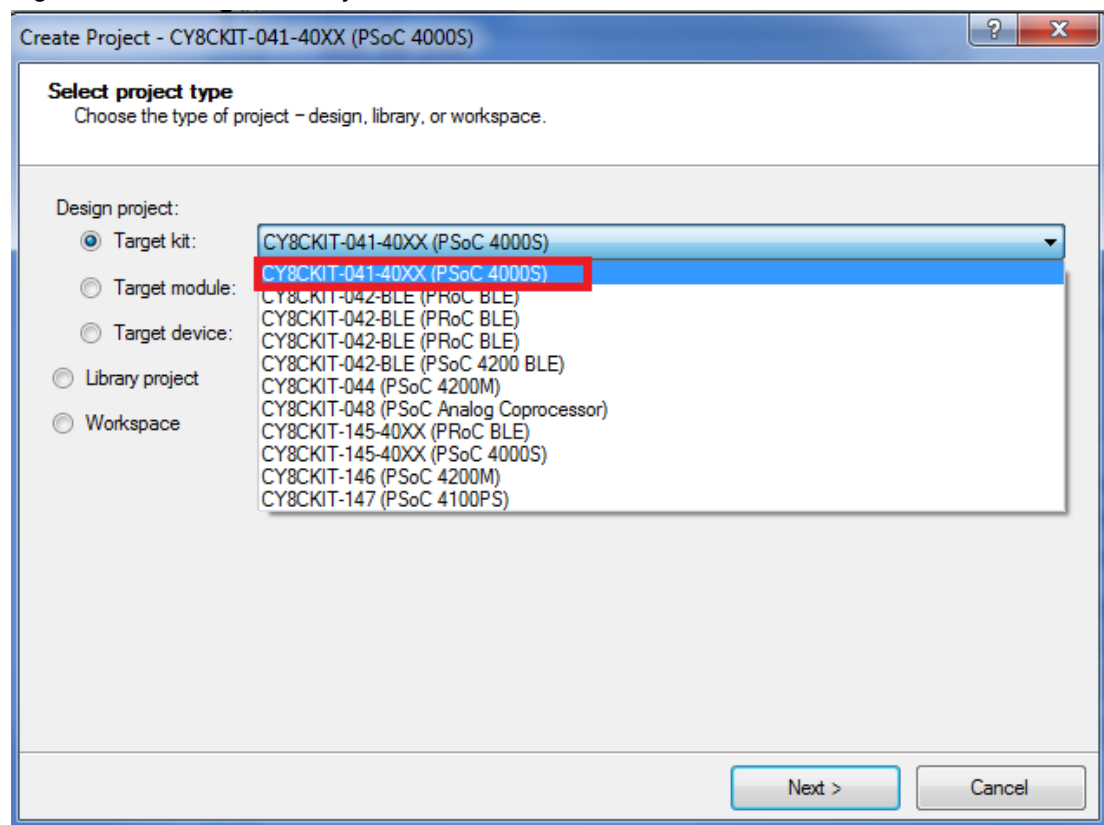


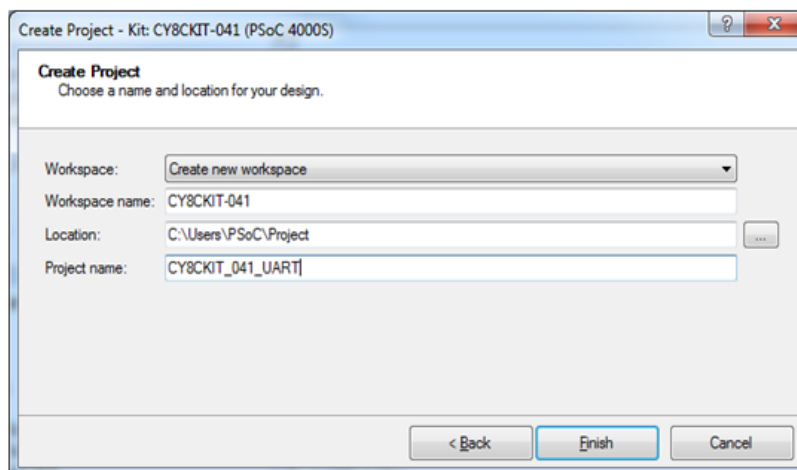
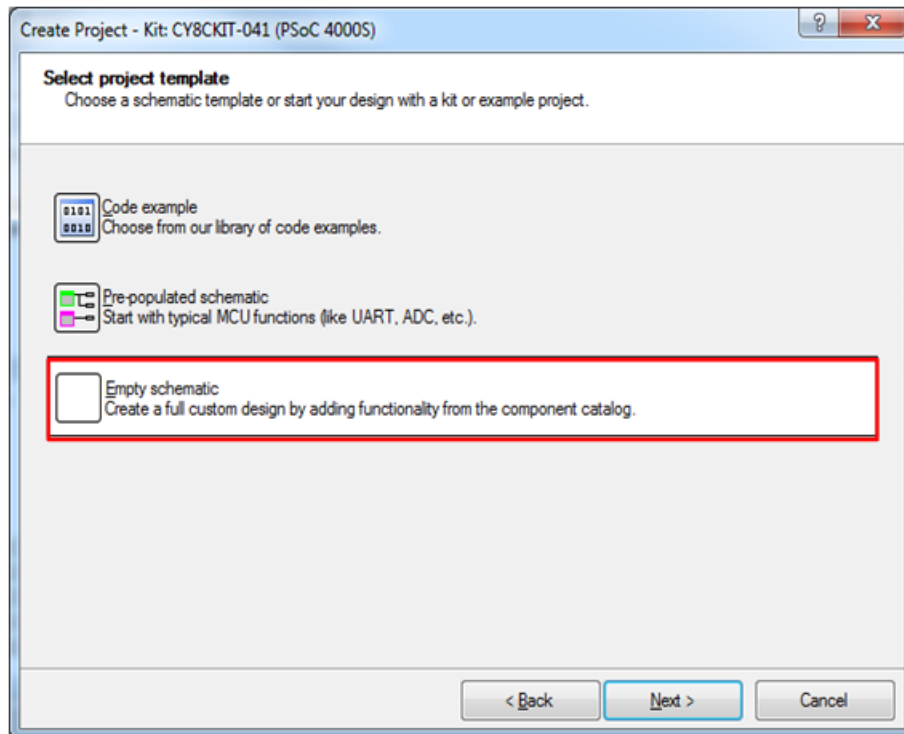
The KitProg2 can act as a USB-UART Bridge. This feature of the KitProg2 is useful to send and receive data between the Cypress device on the kit and a PC. For example, in the PSoC 4 S-Series Pioneer Kit, the KitProg2 USB-UART can be used to print debug messages on COM terminal software running on the PC.

This section demonstrates a method to create a PSoC 4 code example, which communicates with COM terminal software using the KitProg2 USB-UART Bridge. This example uses Windows HyperTerminal as the COM terminal software. If you have a Windows operating system that does not have HyperTerminal, use an alternative terminal software such as PuTTY.

1. Create a new PSoC 4000S project in PSoC Creator, as shown in [Figure 6-1](#). Select a specific location for your project and name the project as desired. You must select the appropriate target hardware (kit) for this project. This example uses CY8CKIT-041-40XX (PSoC 4000S device) as the target hardware. Ensure that the **Select project template** option is set to 'Empty schematic'. This example uses PSoC 4000S as the target device and PSoC 4 S-Series Pioneer Kit as the target board.

Figure 6-1. Create New Project in PSoC Creator







2. Drag and drop a UART (SCB mode) Component from the Component Catalog (see [Figure 6-2](#)) to the TopDesign. The Component Catalog is located along the right of the PSoC Creator window by default. To configure the UART, double-click or right-click the UART Component and select **Configure**, as shown in [Figure 6-3](#).

Figure 6-2. UART Component in Component Catalog

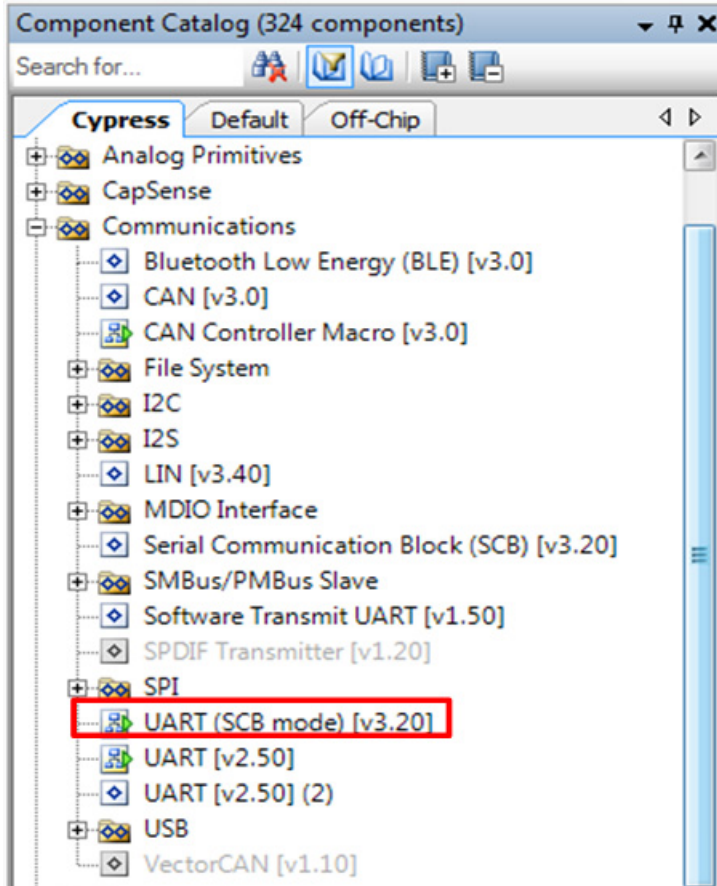
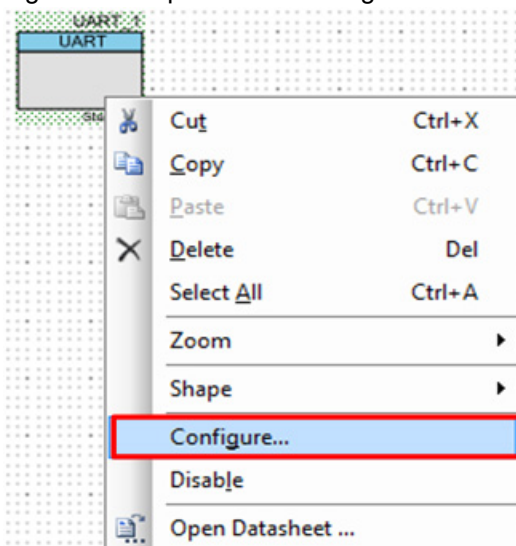


Figure 6-3. Open UART Configuration Window



- Configure the UART Component as shown in [Figure 6-4](#), [Figure 6-5](#), and [Figure 6-6](#), and then click **OK**.

Figure 6-4. UART Configuration Tab Window

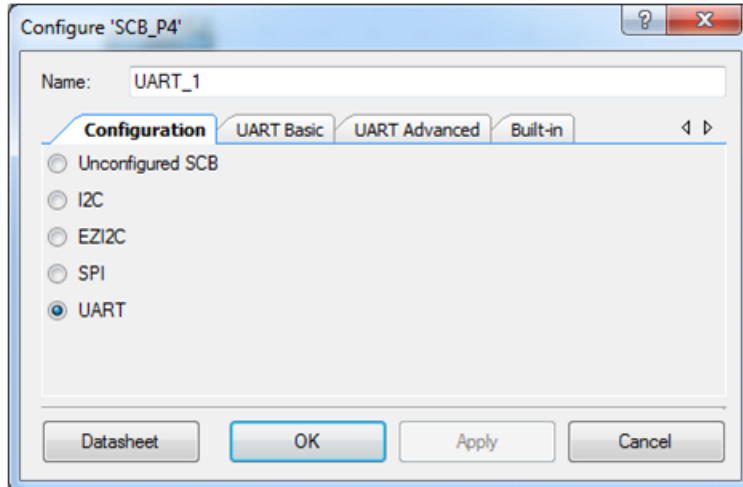


Figure 6-5. UART Basic Tab Window

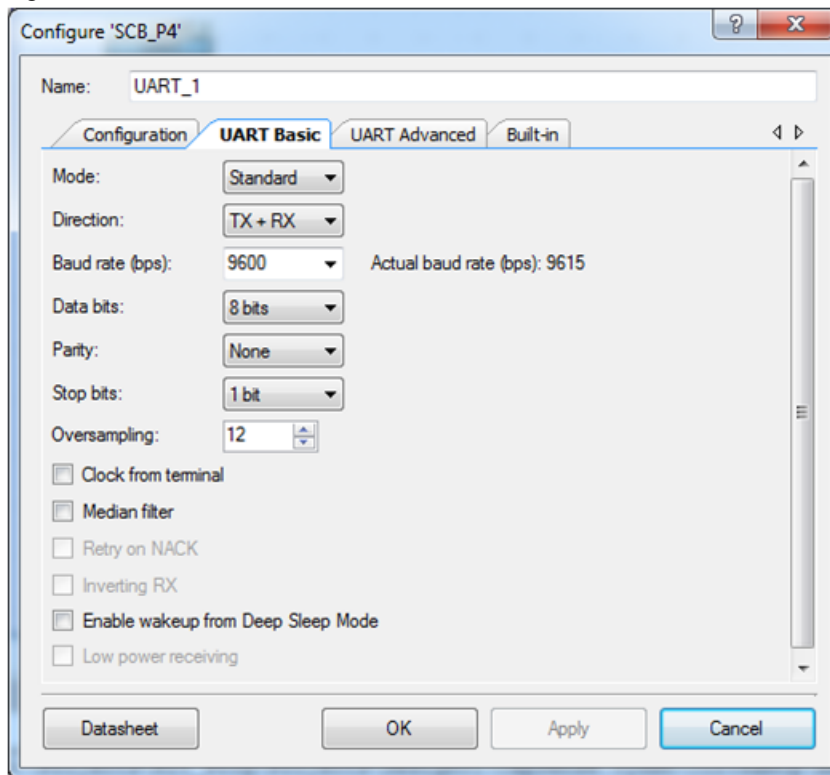
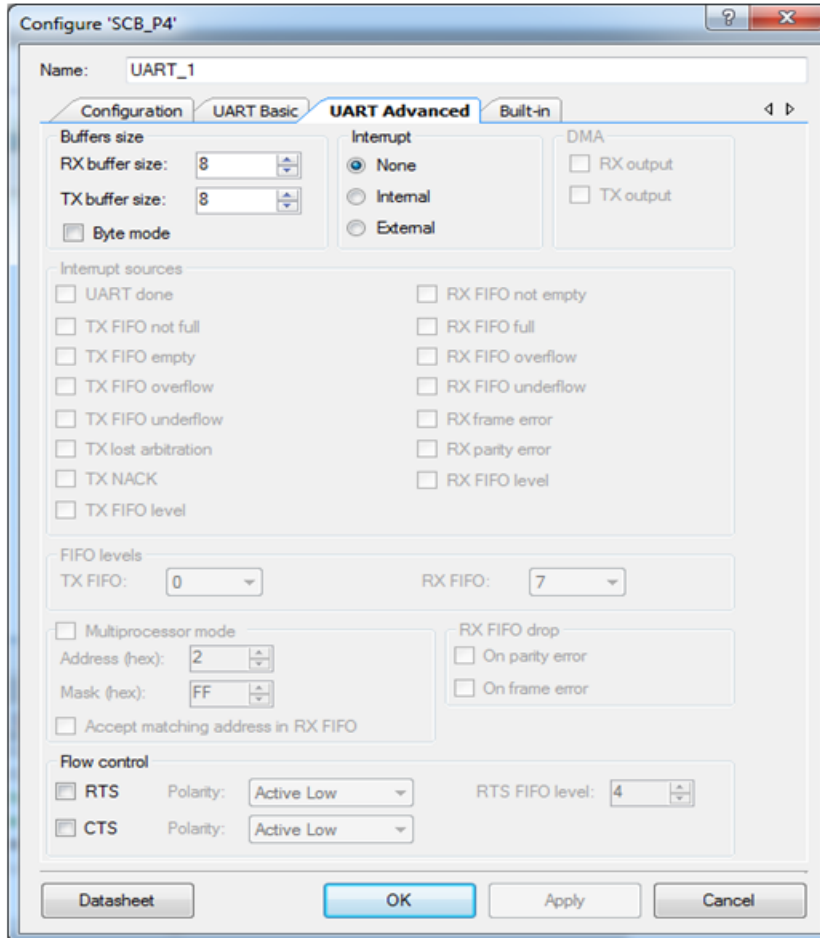


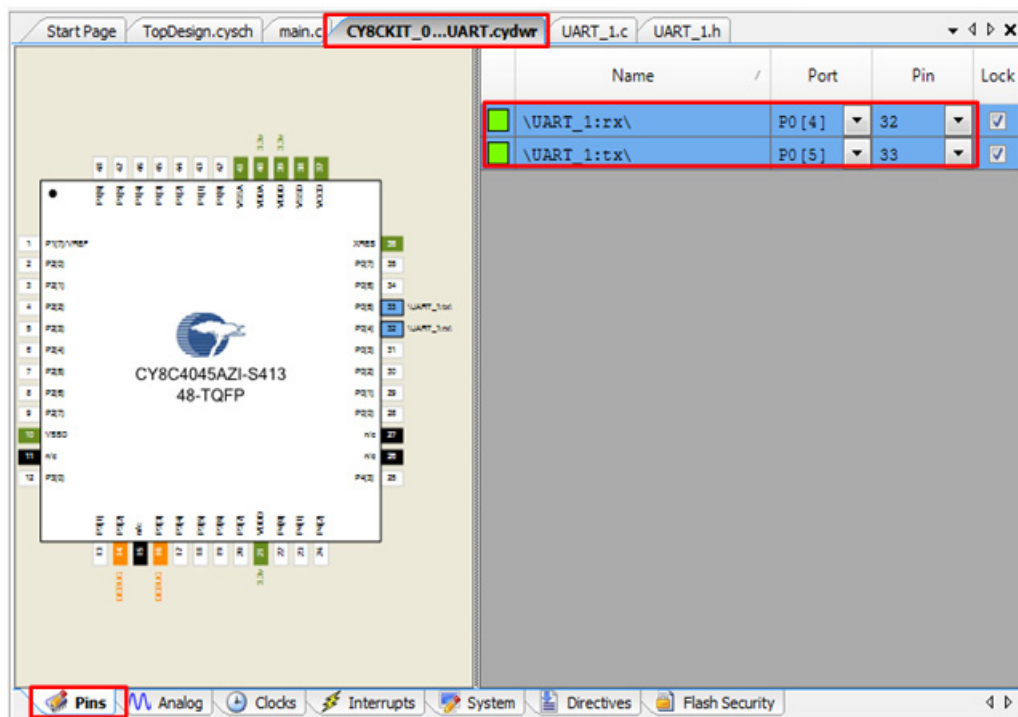
Figure 6-6. UART Advanced Tab Configuration Window



- Select P0[4] for UART RX and P0[5] for UART TX in the **Pins** tab of `<Project_Name>.cydwr`, as shown in Figure 6-7. This can be opened by double clicking on “Pins” under the “Design Wide Resources”. The `<Project_Name>.cydwr` file can be found in the Workspace Explorer window, which is located along the left of the PSoC Creator window. Note that these pins are for the USB-UART interface on the PSoC 4 S-Series Pioneer Kit. If you are using a different kit, refer to the respective kit guide for the appropriate pins.

**Note:** UART RX and UART TX can be routed to any digital pin on PSoC 4 by using the UDB implementation of the UART Component. Here, the SCB implementation of the UART is used, which routes the pins to one of the specific set of pins supported by the device. This will vary depending on the PSoC 4 device used.

Figure 6-7. UART Pin Assignment



5. Place the following code in the *main.c* file. The code echoes any data received through the UART.

**Note:** The *main.c* file can be found under Source Files on the Workspace Explorer window, which is located along the left of the PSoC Creator window by default. Double-click on the file to open it.

6. Build the project by choosing **Build > Build [Project Name]** or pressing **[Shift] [F6]**. After the project is built without errors and warnings, program the project (by choosing **Debug > Program**) to the PSoC 4000S using KitProg2.

```
#include <project.h>
int main()
{
    uint8 ch;
    /* Start SCB UART TX+RX operation */

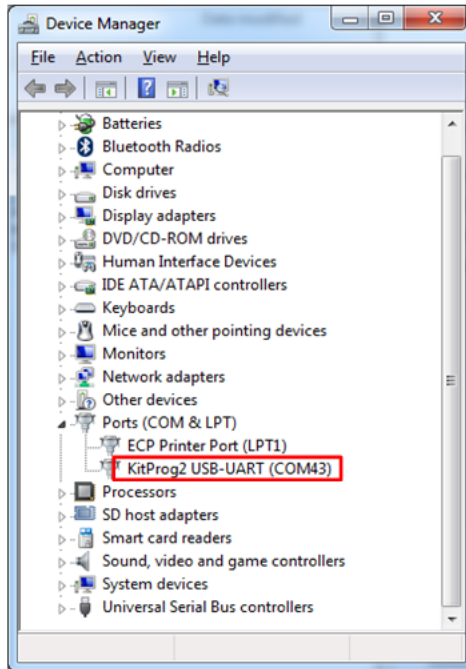
    UART_1_Start();
    /* Transmit String through UART TX Line */

    UART_1_UartPutString("CY8CKIT-041 USB-UART");
    for(;;)
    {
        /* Get received character or zero if nothing has been received yet */
        ch = UART_1_UartGetChar();
        if(0u != ch)
        {
            /* Send the data through UART. This function is blocking and waits
            until there is an entry into the TX FIFO. */
            UART_1_UartPutChar(ch);
        }
    }
}
```

To communicate with the PSoC 4000S device from the terminal software, follow this procedure:

1. Connect the USB Micro-B cable to J6. The kit enumerates as a **KitProg2 USB-UART**, and is available in the **Device Manager** under **Ports (COM & LPT)**. A communication port is assigned to the **KitProg2 USB-UART**, as shown in [Figure 6-8](#).

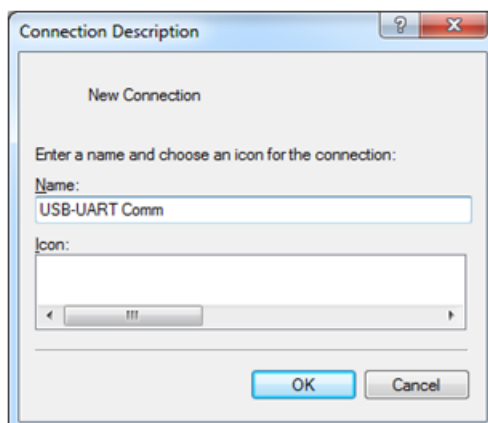
Figure 6-8. KitProg2 USB-UART in Device Manager



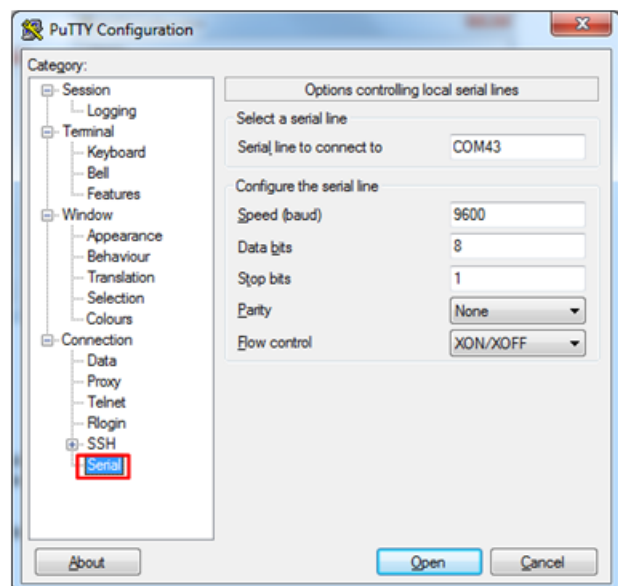
2. Open HyperTerminal, choose **File > New Connection**, enter a name for the new connection, and then click **OK** as shown in [Figure 6-9](#). For PuTTY, double-click the PuTTY application and select **Serial** under **Category**.

Figure 6-9. Open New Connection

HyperTerminal



PuTTY



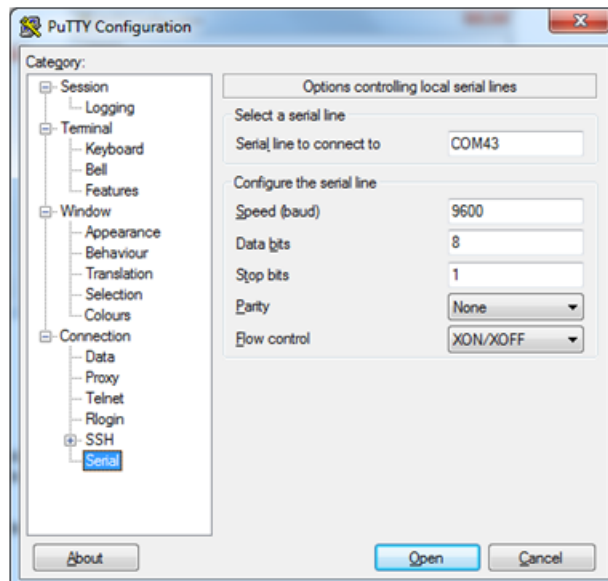
3. A new window opens, where the communication port can be selected. In HyperTerminal, select COMx (the specific communication port that is assigned to the KitProg2 USB-UART) in **Connect using** and click **OK**, as shown in [Figure 6-10](#).

In PuTTY, enter the COMx in **Serial line to connect to**. This example uses COM43.

Figure 6-10. Select Communication Port  
HyperTerminal



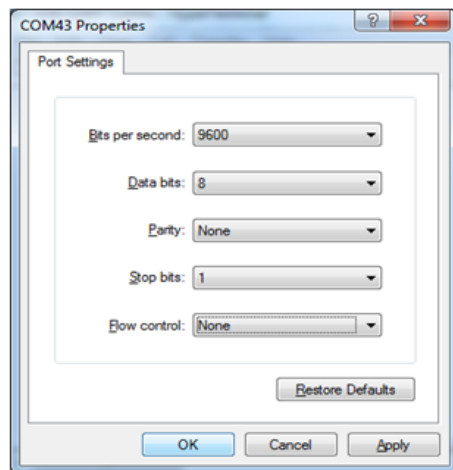
PuTTY



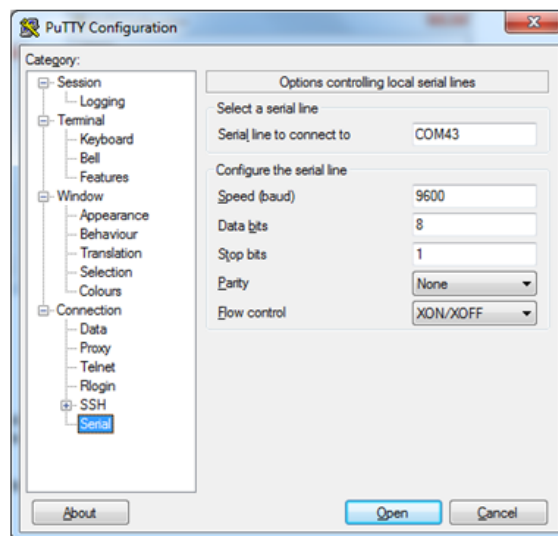
4. In HyperTerminal, select **Bits per second**, **Data bits**, **Parity**, **Stop bits**, and **Flow control** under **Port Settings** and click **OK** (see [Figure 6-11](#)). Ensure that the settings are identical to the UART settings configured for the PSoC 4000S device.

In PuTTY, enter the **Speed (baud)**, **Data bits**, **Stop bits**, **Parity**, and **Flow control** under **Configure the serial line**.

Figure 6-11. Configure the Communication Port  
HyperTerminal



PuTTY

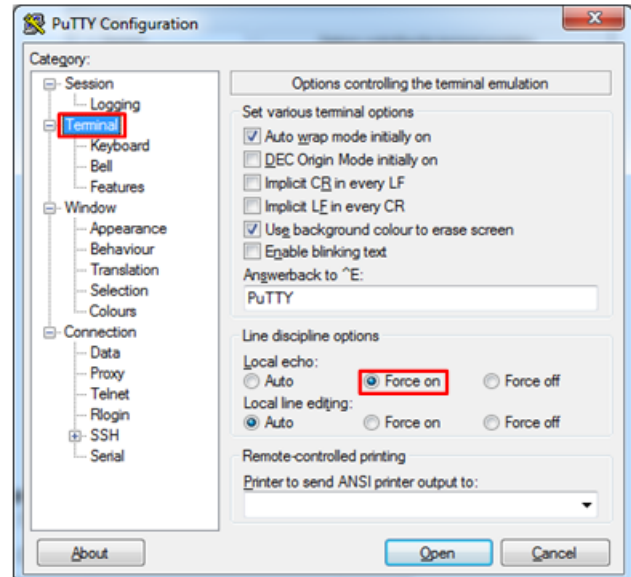
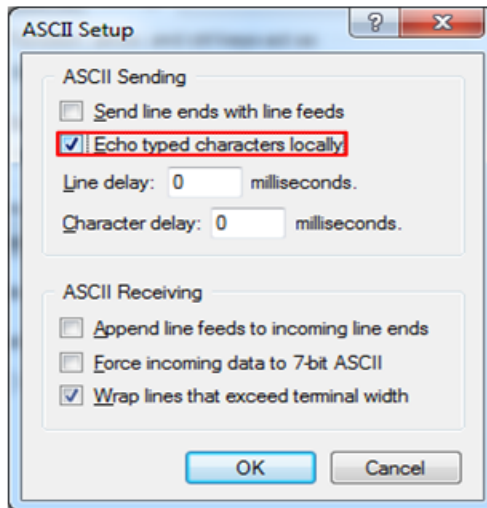


5. Enable **Echo typed characters locally** under **File > Properties > Settings > ASCII Setup** to display the typed characters on HyperTerminal, as shown in [Figure 6-12](#). In PuTTY, select **Force on** under **Terminal > Line discipline options** to display the typed characters on PuTTY, as shown in [Figure 6-12](#).

Figure 6-12. Enable Echo of Typed Characters in HyperTerminal and PuTTY

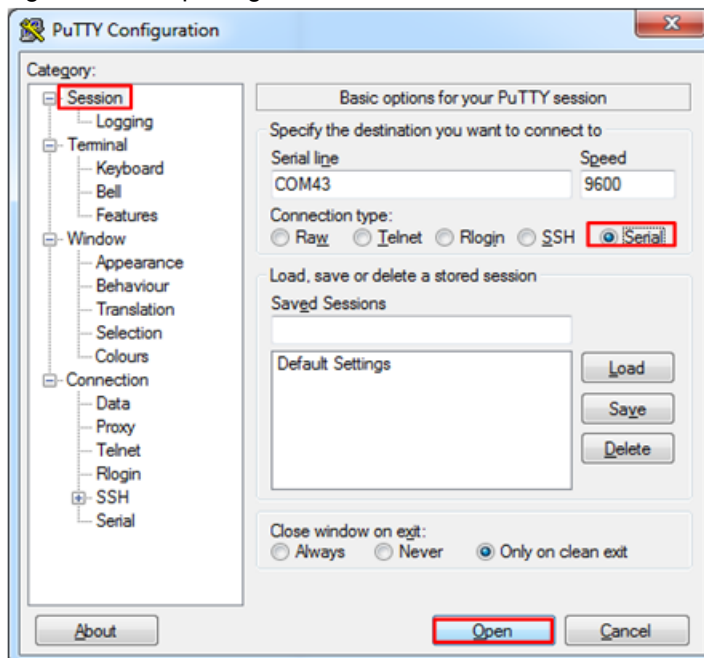
HyperTerminal

PuTTY



6. In PuTTY, click **Session** and select **Serial** under **Connection type**. The **Serial line** shows the communication port (COM43) and **Speed** shows the baud rate selected. Click **Open** to start the communication, as shown in [Figure 6-13](#).

Figure 6-13. Opening Port in PuTTY

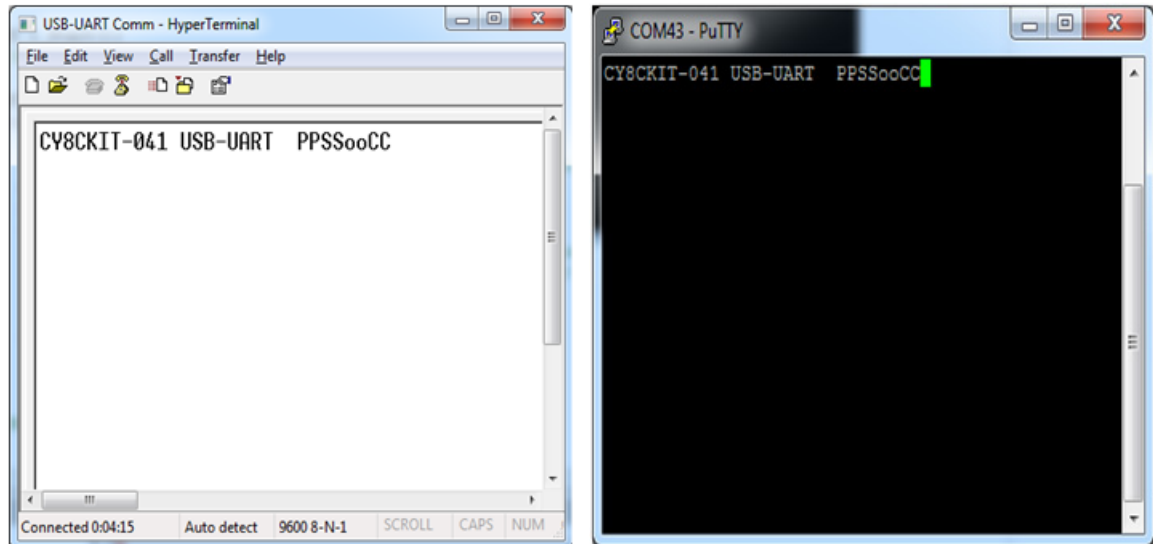




7. The COM terminal software displays both the typed data and the echoed data from the PSoC 4000S UART, as shown in [Figure 6-14](#).

**Note:** The string “CY8CKIT-041 USB-UART” is transmitted when the kit is powered up or reset. If you open the terminal window after the kit has been plugged in, you will not see this message. Press the Reset button on the kit to see the message.

Figure 6-14. Data Displayed on HyperTerminal and PuTTY



## 7. USB-I2C Bridge



The KitProg2 serves as a USB-I2C Bridge that can be used to communicate with USB-I2C software running on a PC. For example, the KitProg2 USB-I2C Bridge can be used to tune the CapSense Component on a PSoC device. This feature is applicable to all kits listed in [Table 2-1 on page 10](#). This section uses the PSoC 4 S-Series Pioneer Kit as an example to demonstrate the KitProg2 USB-I2C Bridge functionality. The following steps describe how to use the USB-I2C Bridge, which can communicate between the Bridge Control Panel (BCP) software and the PSoC 4000S device.

**Note:** For information on how to use the KitProg2 USB-I2C Bridge to tune the CapSense Component, refer to the Manual Tuning Process section in [AN85951 - PSoC 4 CapSense Design Guide](#).

1. Create a new PSoC 4000S project in PSoC Creator. Select a specific location for your project and name the project as desired. You must select the appropriate target hardware (kit) for this project as shown in [Figure 7-1](#). This example uses CY8CKIT-041-40XX (PSoC 4000S device) as the target hardware. Ensure that the **Select project template** option is set to 'Empty schematic' as shown in [Figure 7-2](#). Create the workspace and project name as shown in [Figure 7-3](#).

Figure 7-1. Create New Project in PSoC Creator

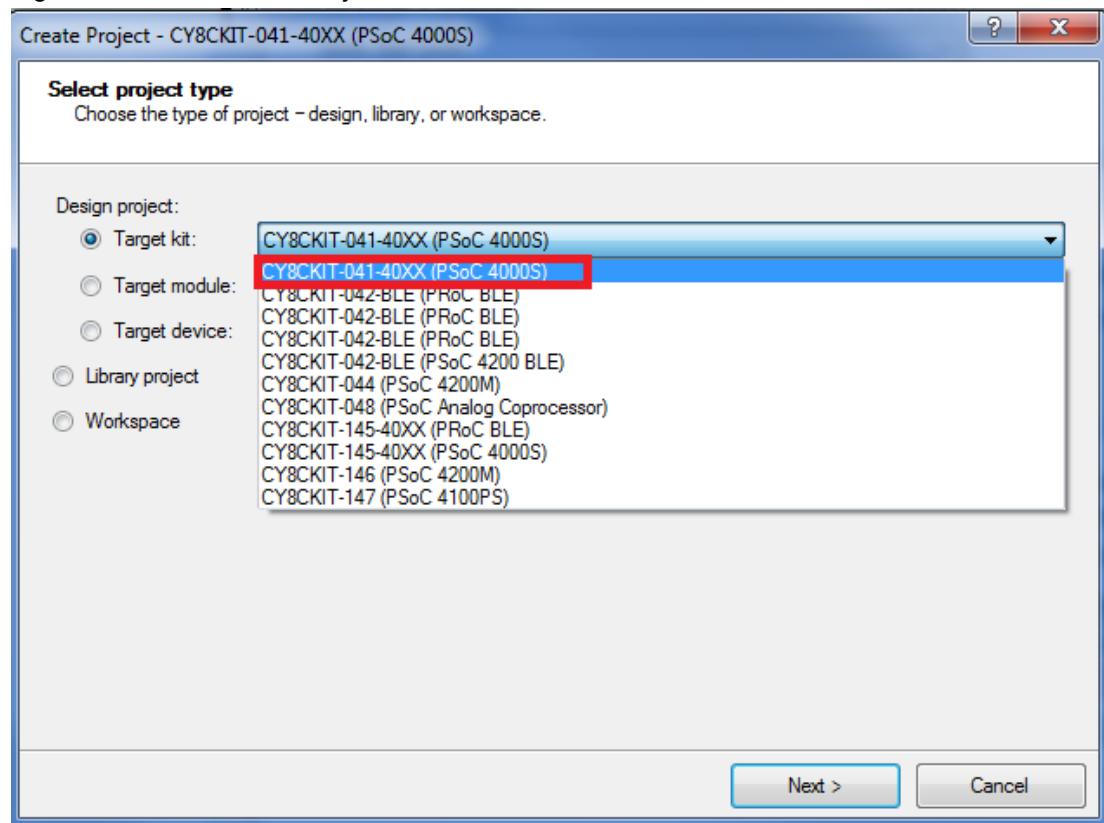


Figure 7-2. Select Empty Schematic

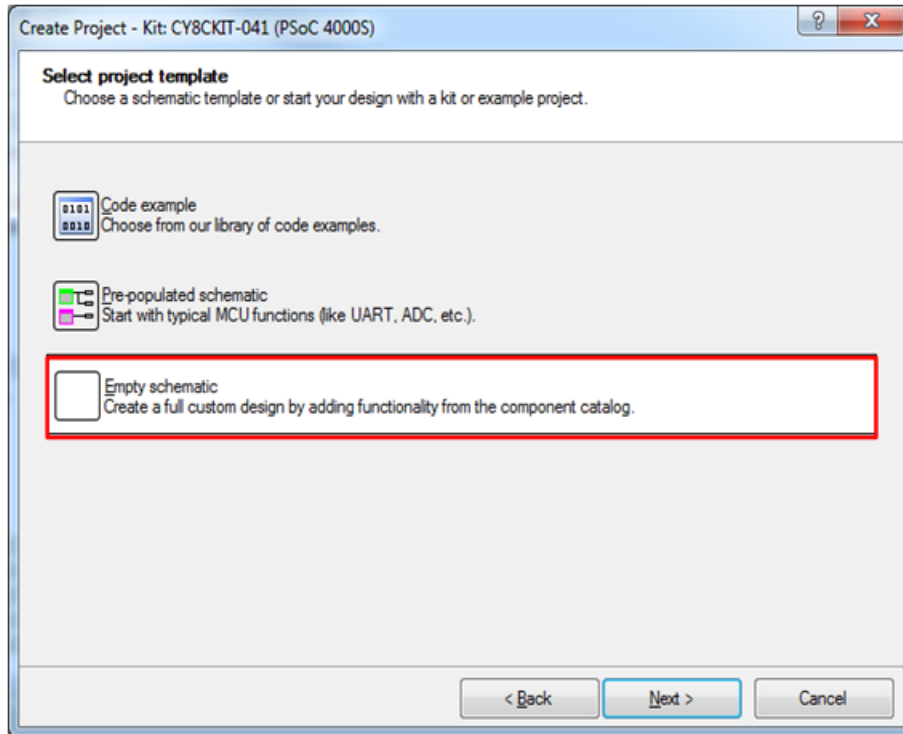
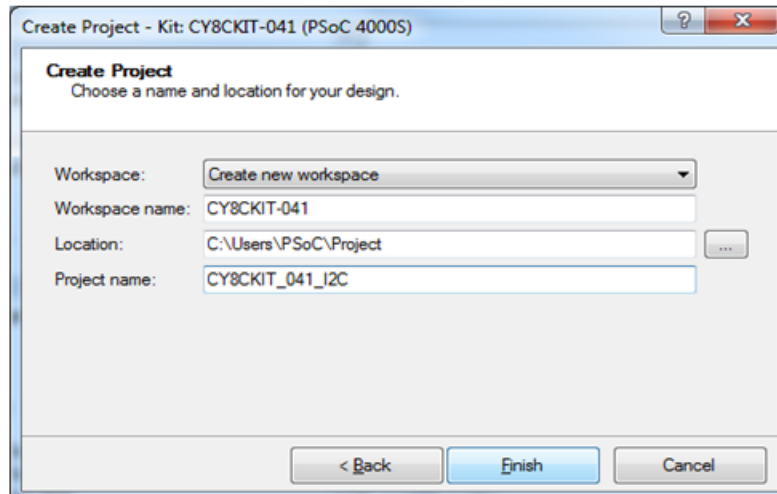


Figure 7-3. Create Workspace



2. Drag and drop an EZI2C Slave (SCB mode) Component from the Component Catalog (see [Figure 7-4](#)) to the TopDesign. The Component Catalog is located along the right of the PSoC Creator window by default. To configure the EZI2C Slave Component, double-click or right-click the **EZI2C Slave Component** and select **Configure**, as shown in [Figure 7-5](#).

Figure 7-4. EZI2C Slave Component in Component Catalog

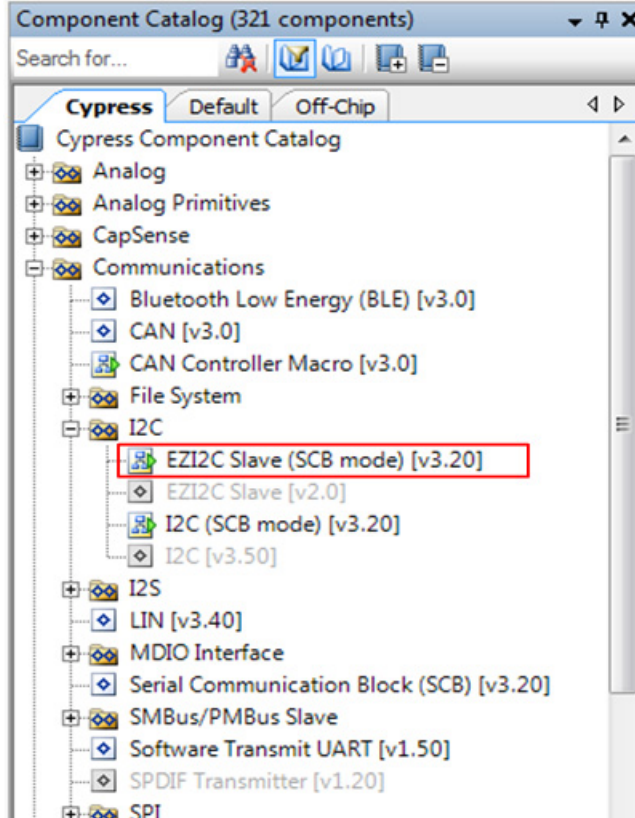
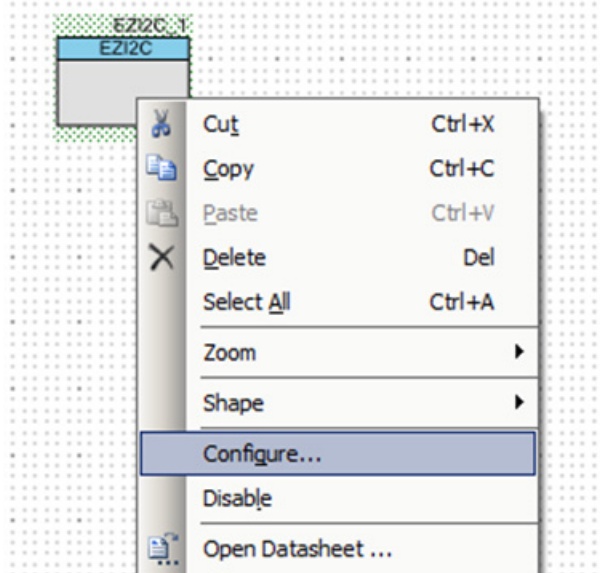


Figure 7-5. Open EZI2C Slave Configuration Window



3. Configure the EZI2C Slave Component as shown in [Figure 7-6](#) and [Figure 7-7](#); then, click **OK**.

Figure 7-6. Configuration Tab

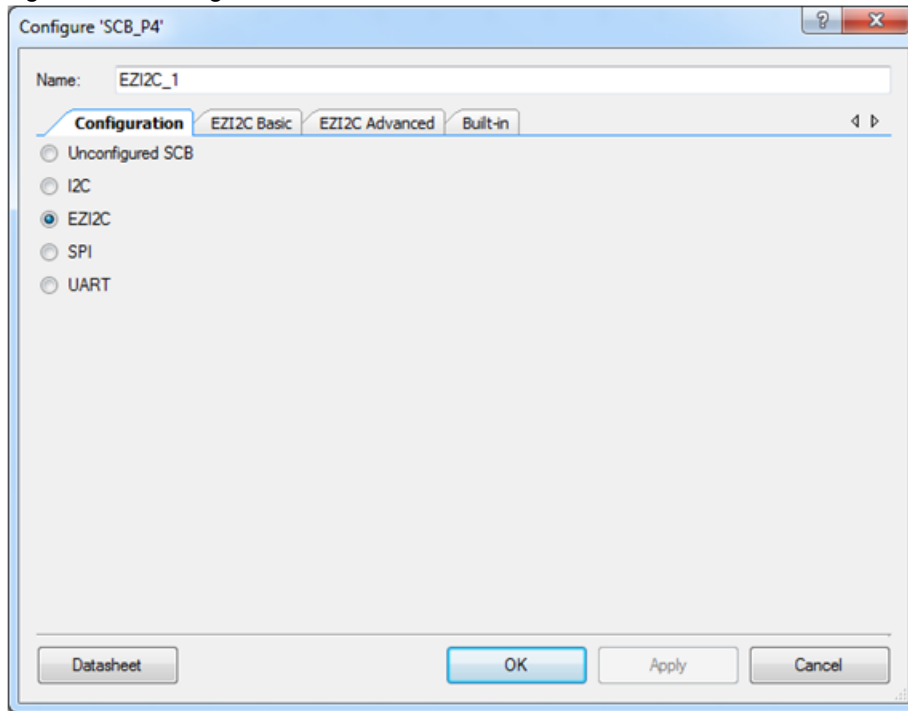
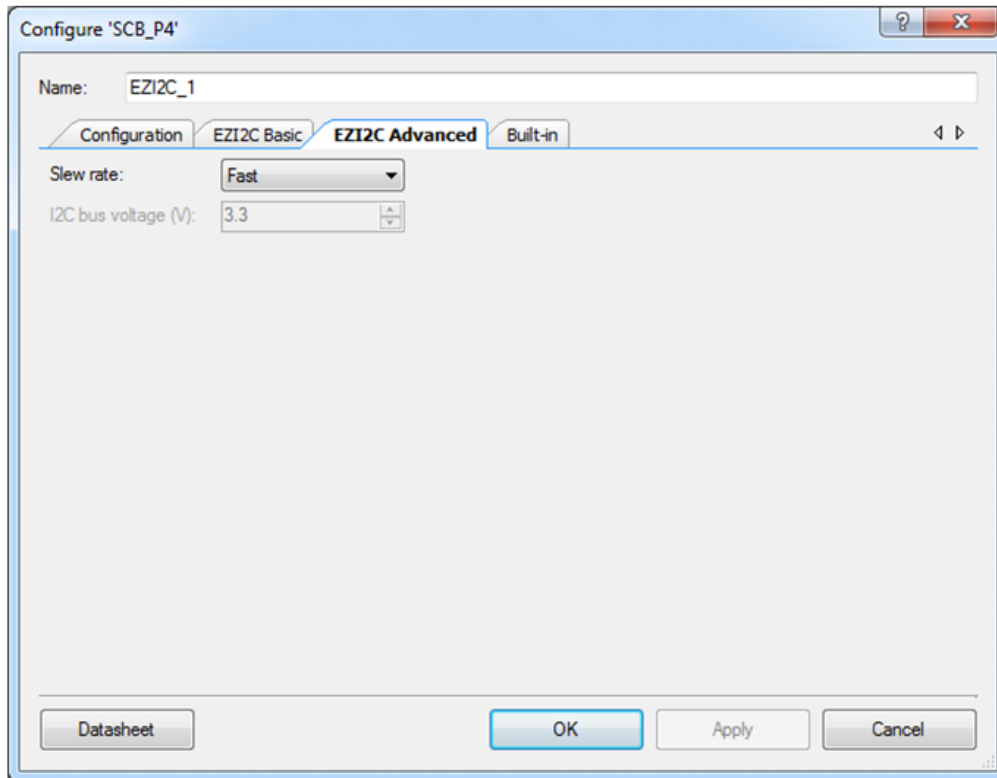
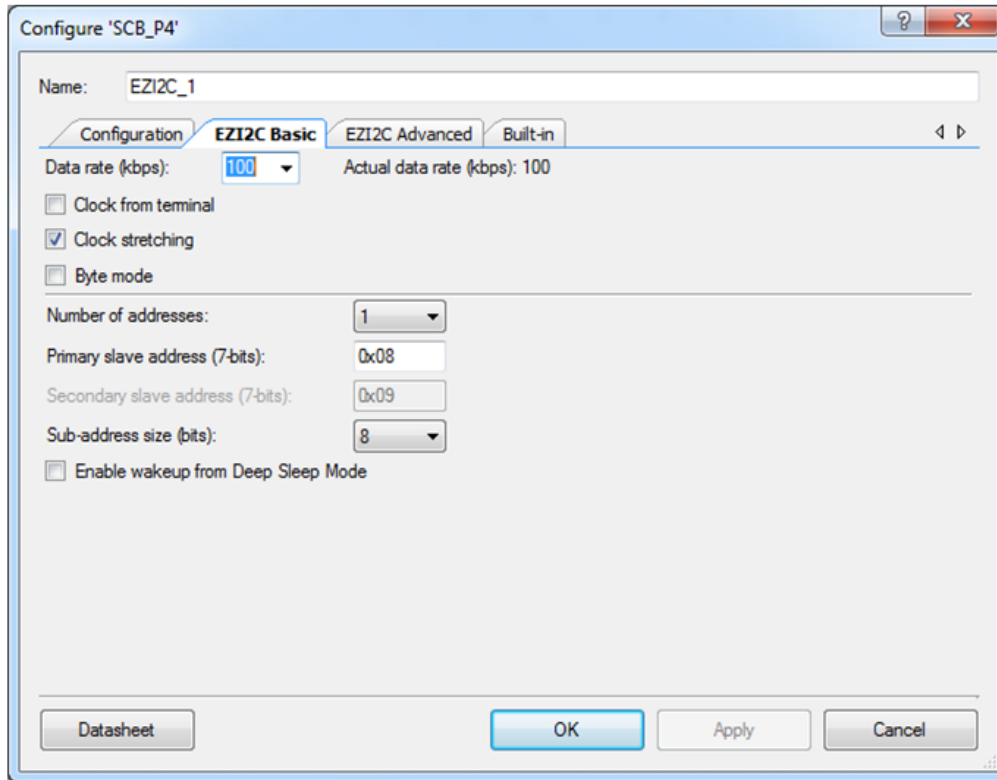
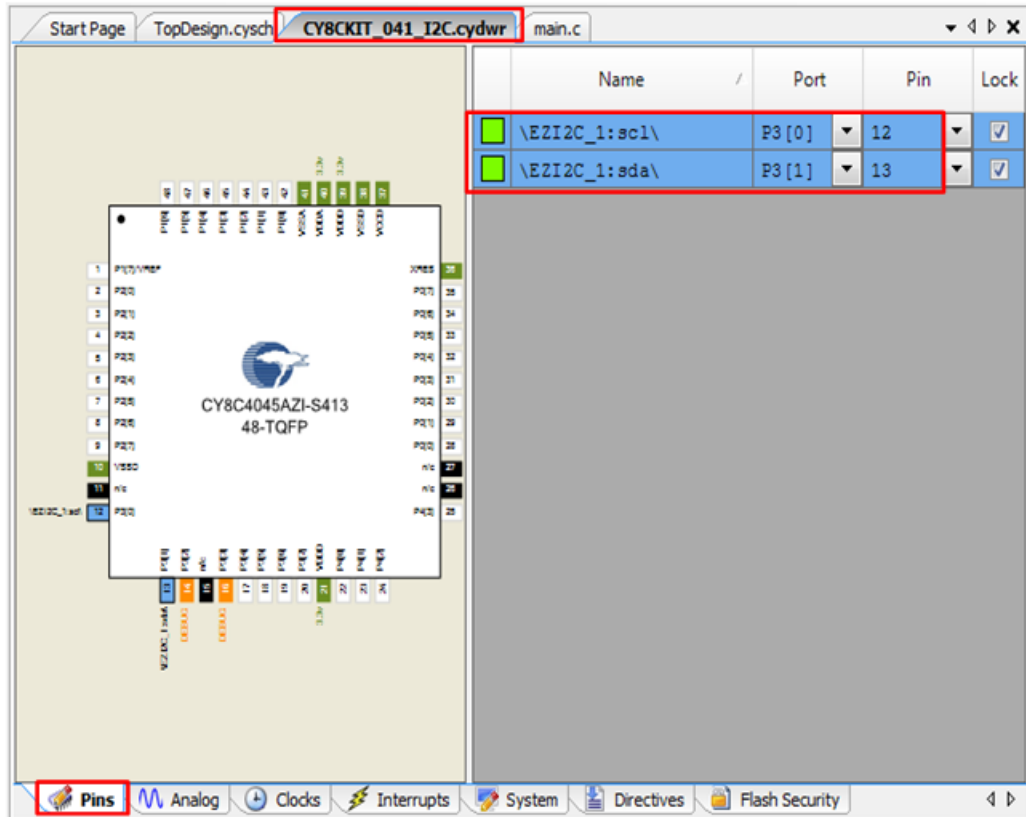


Figure 7-7. EZI2C Slave Basic and Advanced Tabs



4. Select pin P3[0] for the I2C SCL and pin P3[1] for the I2C SDA in the **Pins** tab of `<Project_Name>.cydwr`, as shown in Figure 7-8. This can be opened by double clicking on “Pins” under the “Design Wide Resources”. The `<Project_Name>.cydwr` file can be found in the Workspace Explorer window, which is located along the left of the PSoC Creator window. Note that these are the pins for the USB-I2C interface on the PSoC 4 S-Series Pioneer Kit. If you are using a different kit, refer to the respective kit guide for the appropriate pins.

Figure 7-8. Select Pins in cydwr



5. Place the following code in the *main.c* file. The code will enable the PSoC 4000S device with the BCP application using the EZI2C Slave interface.

**Note:** The *main.c* file can be found on the Workspace Explorer window, which is located along the left of the PSoC Creator window by default. Double-click on the file to open it.

```
#include <project.h>

#define BUF_SIZE                0x0A
#define READ_WRITE_SIZE        0x05

int main()
{
    /* I2C Read/Write Buffer. */
    uint8 i2cBuffer[BUF_SIZE] = {0x01, 0x02, 0x03, 0x04, 0x05,
                                   0x0A, 0x0B, 0x0C, 0x0D, 0x0E};

    CyGlobalIntEnable;
    EZI2C_1_Start();

    /* This API sets the buffer and address boundary to which the external
     * master can communicate. In this example, external master can read
     * from and write to the first 5 bytes of the i2cBuffer and read bytes
     * from all the 10 bytes of the i2cBuffer array. */
    EZI2C_1_EzI2CSetBuffer1(BUF_SIZE, READ_WRITE_SIZE, i2cBuffer);

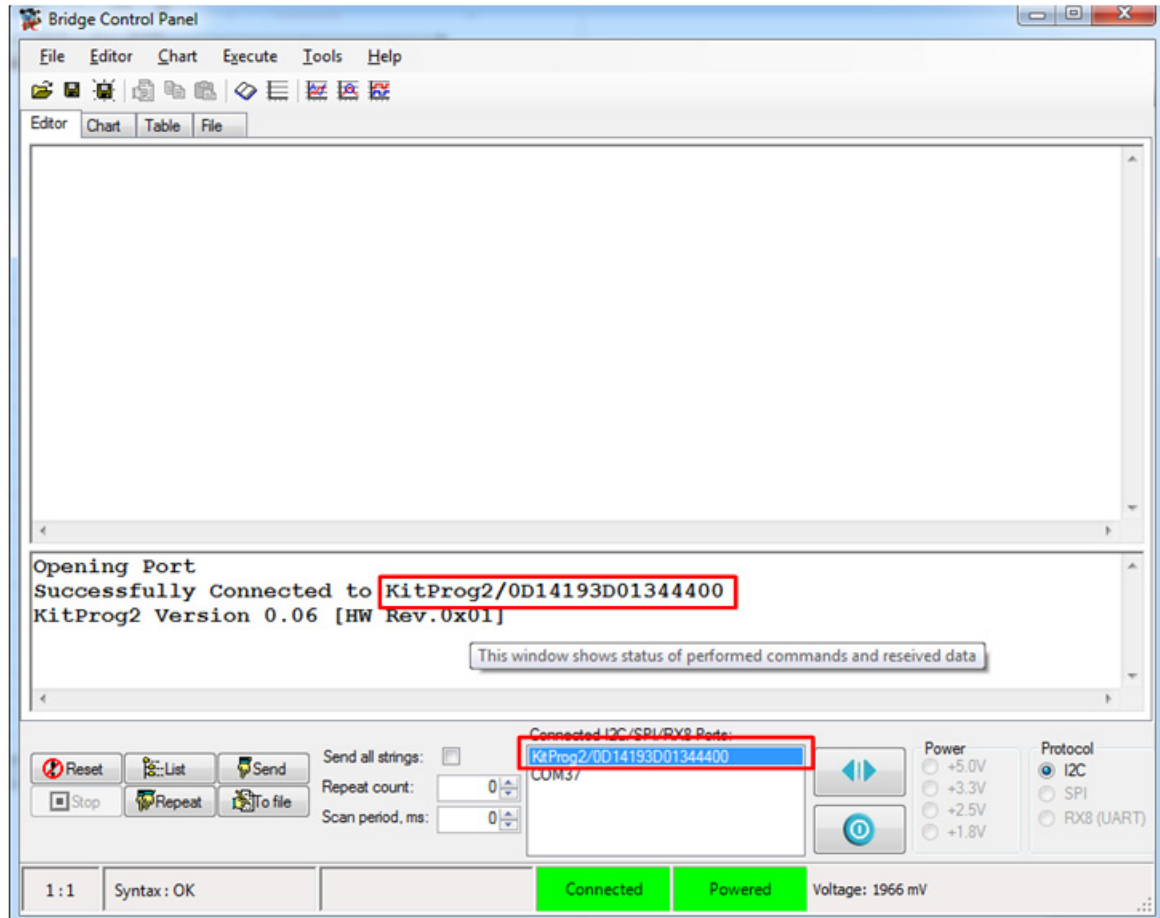
    for (;;)
    {
    }
}
```

6. Build the project by choosing **Build > Build Project** or pressing **[Shift] [F6]**. After the project is built without errors and warnings, program (**[Ctrl] [F5]**) this project onto the PSoC 4000S using KitProg.
7. Open BCP from **Start > All Programs > Cypress > Bridge Control Panel <version> > Bridge Control Panel <version>**.



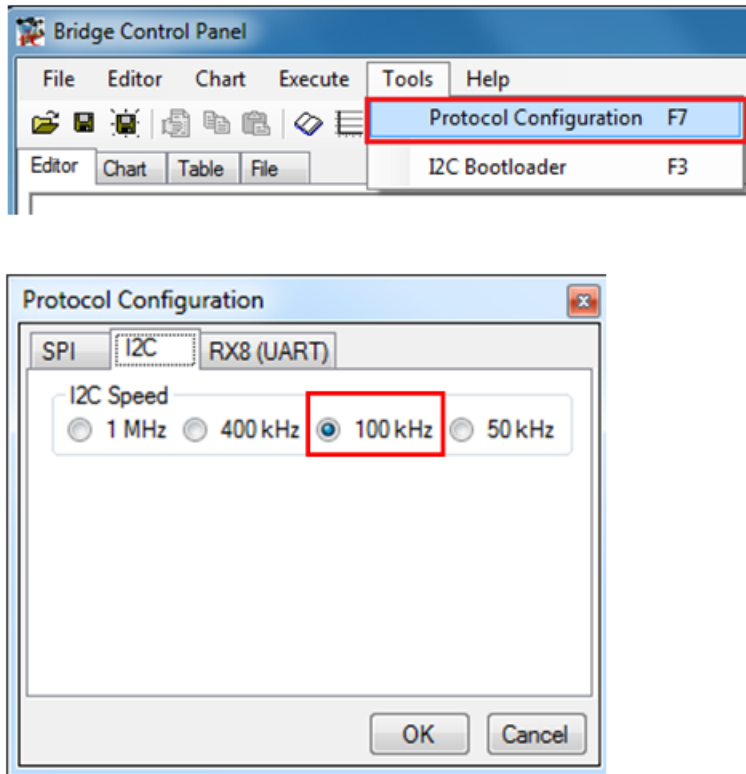
8. Select **KitProg2/<serial number>** under **Connected I2C/SPI/RX8 Ports**, as shown in [Figure 7-9](#).
9. If the KitProg2 firmware is not the most recent version the connection will not work. See [Updating the KitProg2 Firmware on page 17](#) to update the KitProg2 firmware.

Figure 7-9. Connecting to KitProg2 in BCP



10. Open **Protocol Configuration** from the Tools menu and select the appropriate **I2C Speed**, as shown in [Figure 7-10](#). Ensure that the I2C speed is the same as the one configured in the EZI2C Slave Component. Click **OK** to close the window.

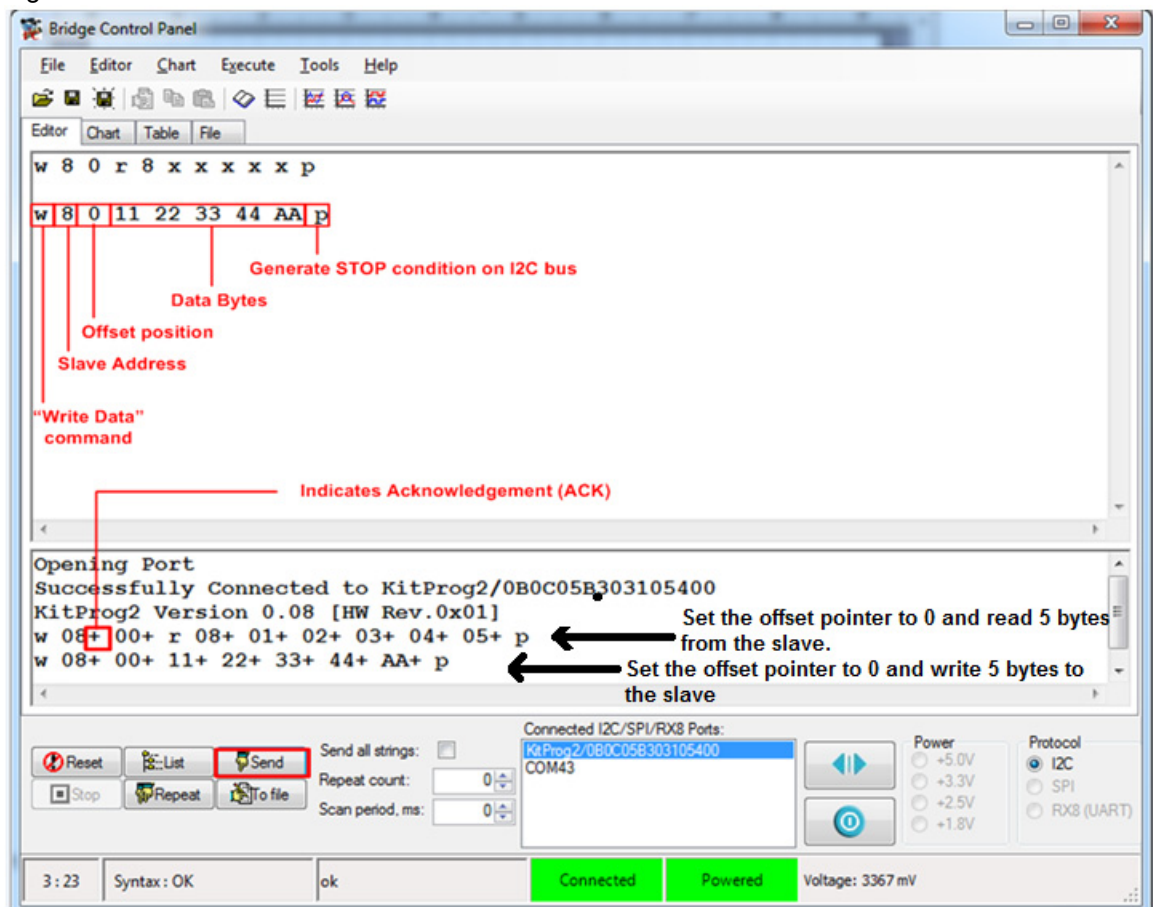
Figure 7-10. Opening Protocol Configuration Window in BCP



11. The buffer in the EZI2C slave is initialized with the data 0x01, 0x02, 0x03, 0x04, and 0x05 after power-on or reset. Send the Read command from the BCP to read the initial data with the slave address 0x08 (first command in Figure 7-11). The EZI2C Slave requires an additional write to be sent from the BCP to set the offset address from/to where the data bytes are read/written. Use a write command to set the read offset and then issue the read command. In this example, the offset is set to '0' so the five data bytes are read starting from the beginning of the buffer. The log shows the initial data. After reading, transfer five bytes of data from the BCP to the I2C device with slave address 0x08. The five bytes sent are 0x11, 0x22, 0x33, 0x44, and 0xAA as shown in the second command of Figure 7-11. Type the command shown in Figure 7-11 and press **[Enter]** or click the **Send** button in the BCP. The log shows whether the transaction was successful. A "+" after a byte indicates that the transaction was successful, and a "-" indicates that the transaction failed.

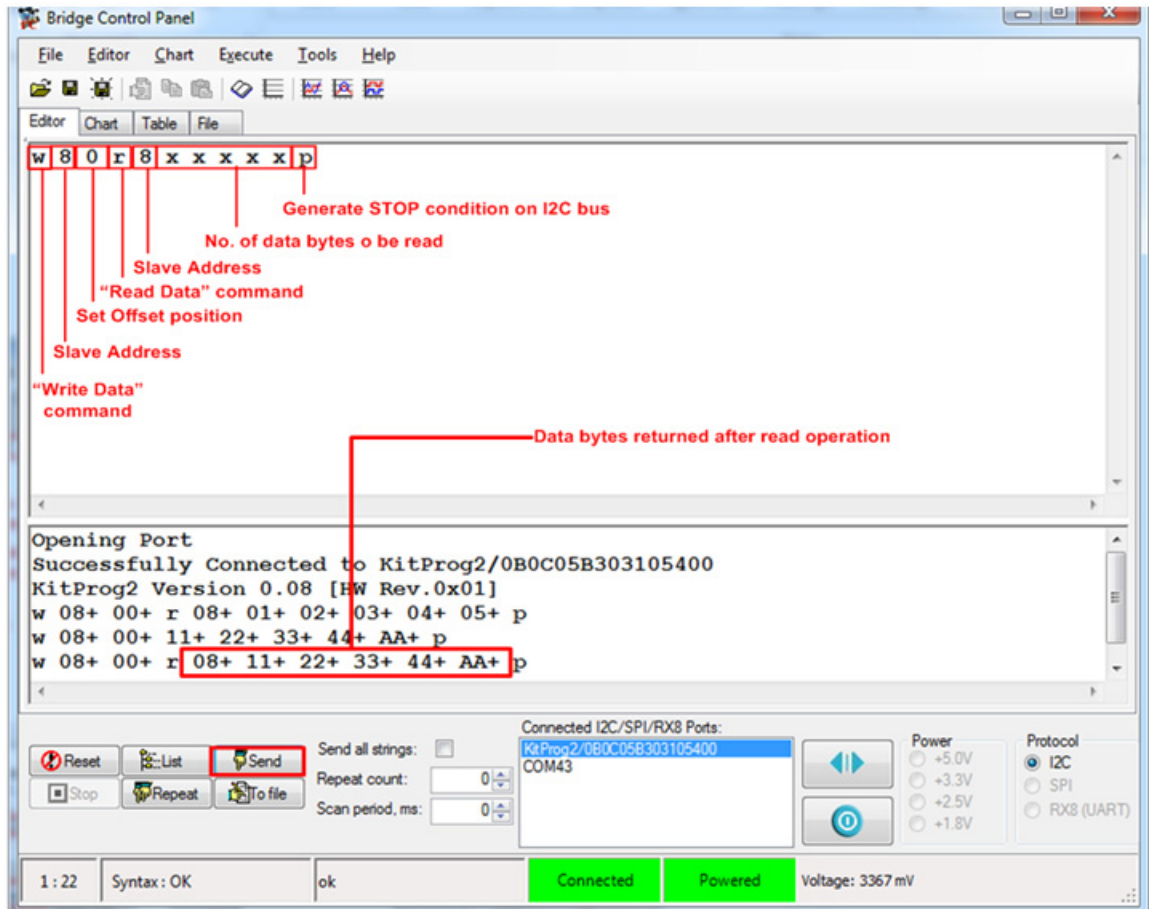
**Note:** You can add additional lines of commands by pressing **[Ctrl] [Enter]**. To execute any line, click on that line and press **[Enter]** or click the **Send** button.

Figure 7-11. Enter Commands in BCP



12. From the BCP, read back the five bytes of data just written from the I2C slave device with slave address 0x08. The log shows if the transaction was successful, as shown in [Figure 7-12](#).

Figure 7-12. Read Data Bytes from BCP



Refer to **Help > Help Contents** in the BCP or press **[F1]** for more information on the I2C commands. Refer to the EZI2C component datasheet for more information on the EZI2C protocol.

## 8. USB-SPI Bridge



The KitProg2 serves as a USB-SPI bridge that can be used to communicate with USB-SPI software running on a PC. This section uses the PSoC 6 BLE Kit as an example to demonstrate the KitProg2 USB-SPI Bridge functionality. The following steps describe how to use the USB-SPI bridge, which can communicate between the Bridge Control Panel (BCP) software and the PSoC 6 BLE device.

1. Create a new PSoC 6 BLE project in PSoC Creator. Select a specific location for your project and name the project as desired. You must select the appropriate target hardware (kit) for this project as shown in [Figure 8-1](#). This example uses CY8CKIT-062 kit (PSoC 6 BLE device) as the target hardware. Ensure that the **Select project template** option is set to 'Empty schematic' as shown in [Figure 8-2](#). Create the workspace and project name as shown in [Figure 8-3](#).

Figure 8-1. Create New Project in PSoC Creator

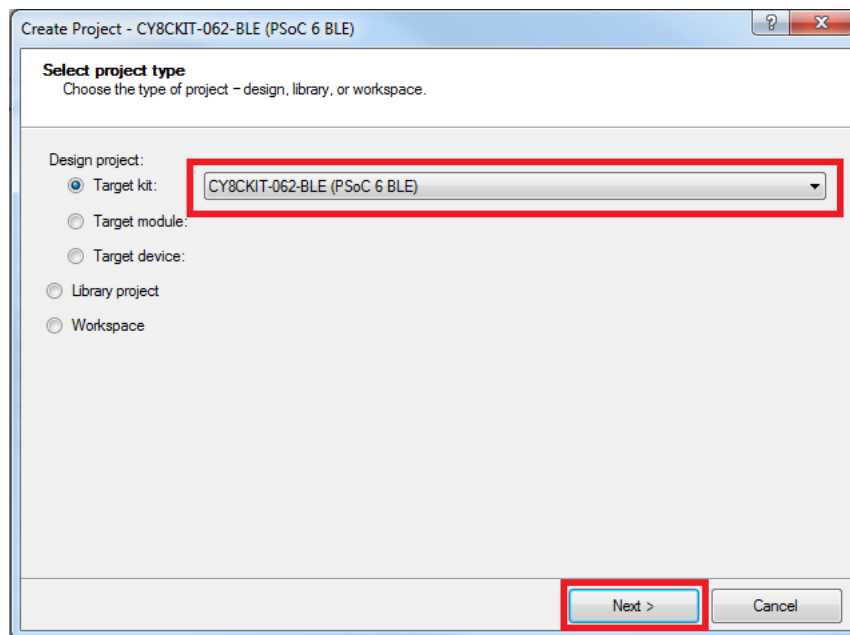


Figure 8-2. Select Empty Schematic

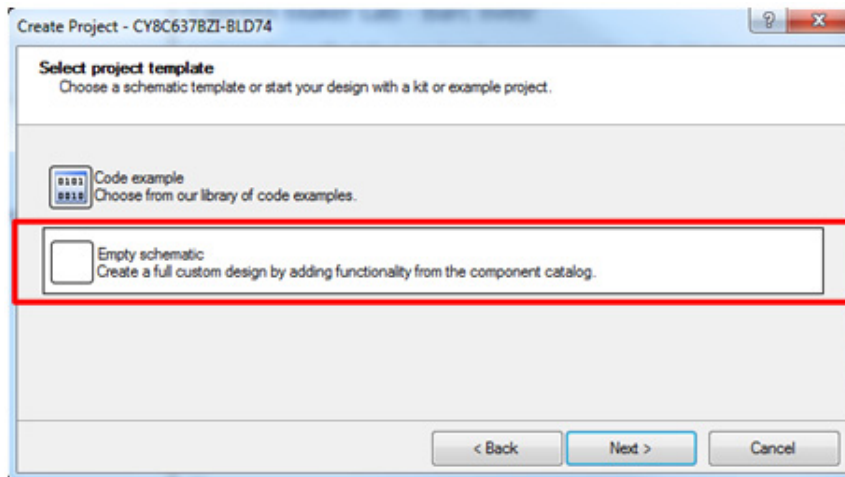
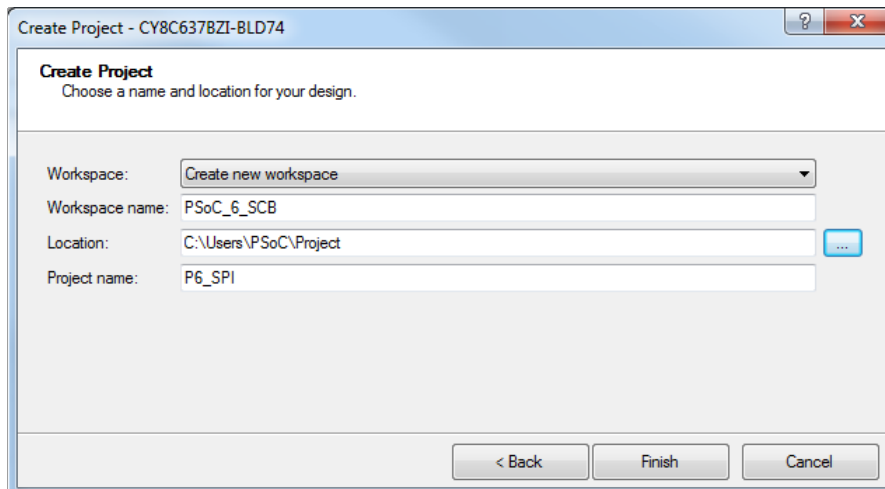
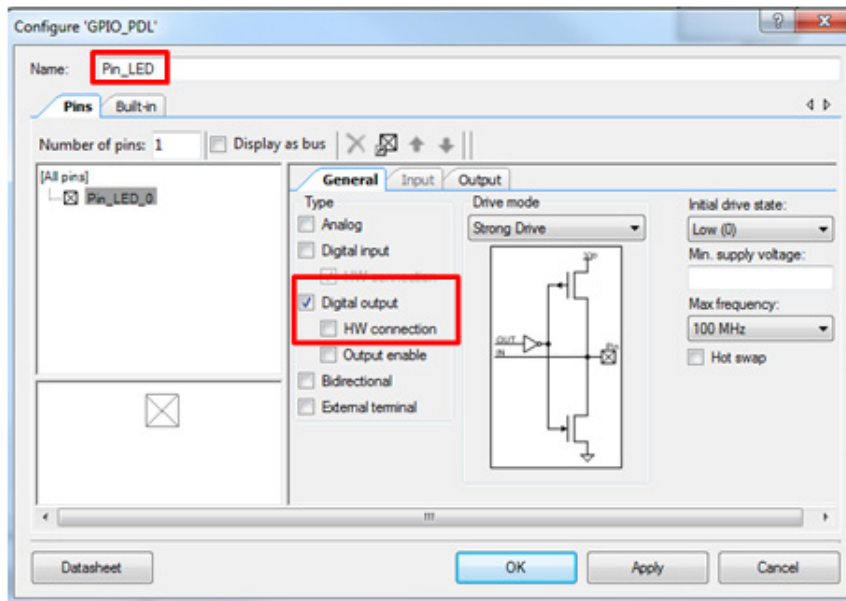


Figure 8-3. Create Workspace



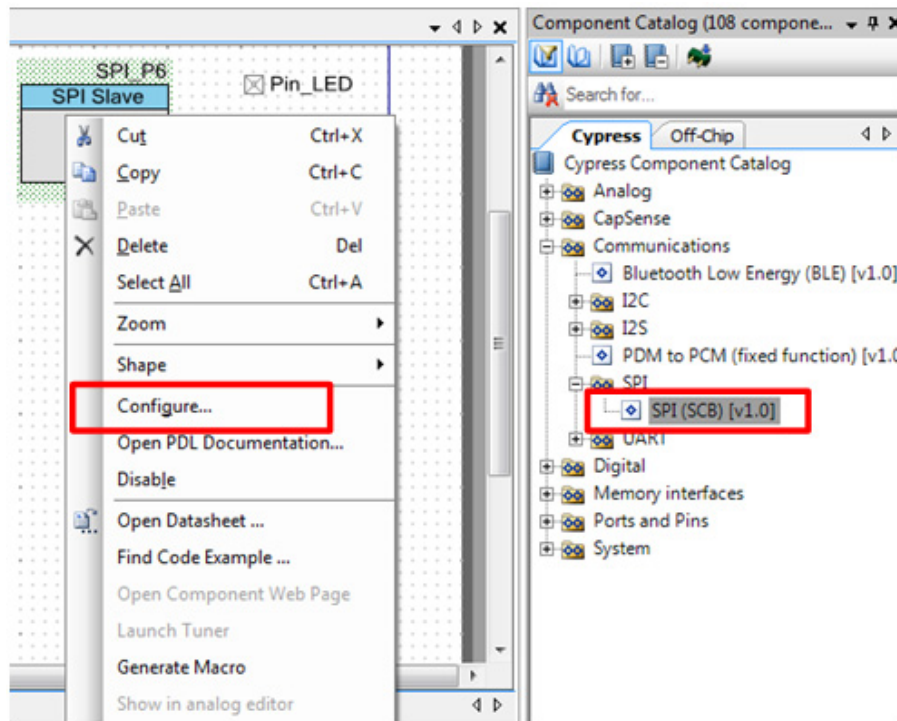
2. Drag and drop an SPI component and digital output pin from the component catalog to the Top-Design. The component catalog is located along the right of the PSoC creator window by default.
3. Double-click the digital output pin to configure the pin. Set the pin name as **Pin\_LED** and uncheck the hardware connection as shown in [Figure 8-4](#).

Figure 8-4. Configuring the output pin



4. To configure the SPI component, double-click or right-click the **SPI Component** and select **Configure**, as shown in [Figure 8-5](#).

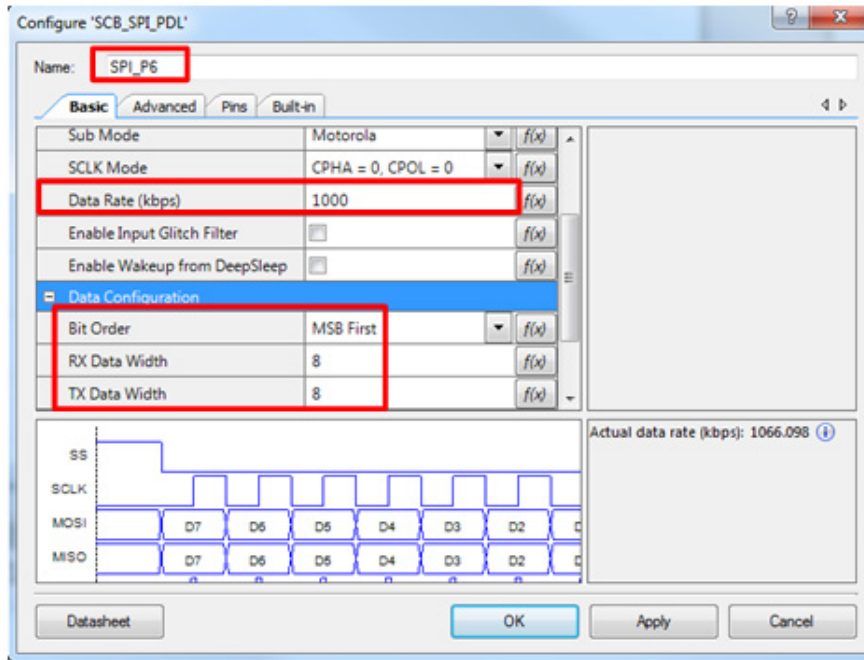
Figure 8-5. SPI Component in Component Catalog and configuring SPI Component





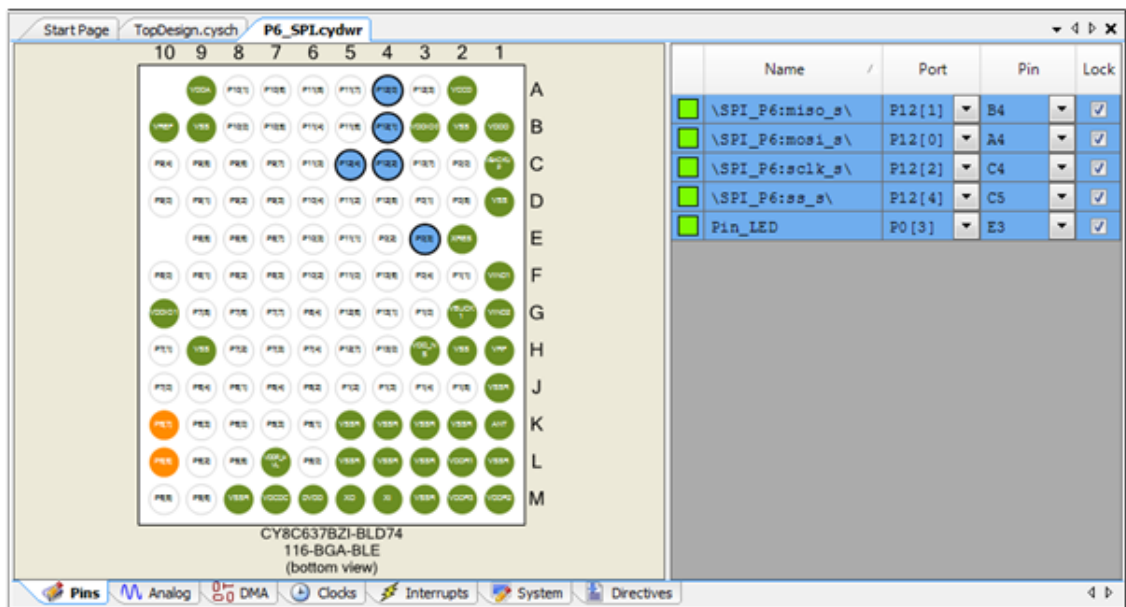
- Configure the SPI Slave Component as shown in [Figure 8-6](#) then click **OK**.

Figure 8-6. Configuring SPI Component



- Select pin P12[0] for SPI\_MOSI, P12[1] for SPI\_MISO, P12[2] for SPI\_SCLK, P12[4] for SPI\_SS and P0[3] for the digital output pin Pin\_LED in the **Pins** tab of <Project\_Name>.cydwr, as shown in [Figure 8-7](#). The <Project\_Name>.cydwr file is available in the Workspace Explorer window, which is located along the left of the PSoC Creator window by default. Double-click on the file to open it. Note that these are the pins for the USB-SPI interface on the PSoC 6 BLE Pioneer Kit. If you are using a different kit, refer to the respective kit guide for the appropriate pins.

Figure 8-7. Select Pins for SPI interface and the output pin





7. Place the following code in the *main\_cm0p.c* file. The code will enable the PSoC 6 BLE device to communicate with the BCP application using the SPI Slave interface. The function of the code is to control LED ON/OFF (LED 5) on the CY8CKIT-062 kit based on the command received from the BCP. A command word of 0x00 turns OFF the LED and 0x01 turns ON the LED.

**Note:** The *main\_cm0p.c* file can be found on the Workspace Explorer window, which is located along the left of the PSoC Creator window by default. Double click on the file to open it.

```
#include <project.h>

#define BUFFER_SIZE          1
#define LED_ON               0
#define LED_OFF              1

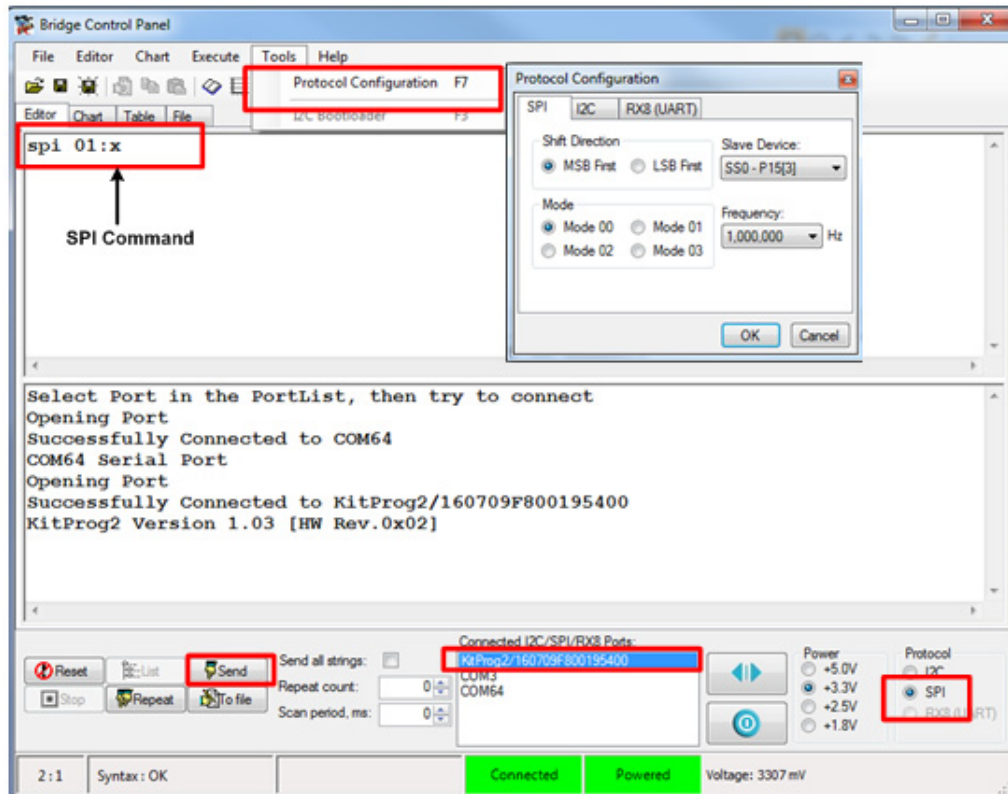
int main(void)
{
    __enable_irq(); /* Enable global interrupts. */
    /* Enable CM4.  CY_CORTEX_M4_APPL_ADDR must be updated if CM4 memory
    layout is changed. */
    Cy_SysEnableCM4(CY_CORTEX_M4_APPL_ADDR);
    int8 RxBuffer[BUFFER_SIZE];
    RxBuffer[0]=0;
    /* Place your initialization/startup code here (e.g. MyInst_Start()) */
    SPI_P6_Start();
    for (;;)
    {
        while(SPI_P6_IsBusBusy());

        SPI_P6_ReadArray((void*)RxBuffer,BUFFER_SIZE);
        SPI_P6_ClearRxFifo();

        switch(RxBuffer[0])
        {
            case 0x00:
                Cy_GPIO_Write(Pin_LED_0,LED_OFF); // Turn the LED OFF
                break;
            case 0x01:
                Cy_GPIO_Write(Pin_LED_0,LED_ON); // Turn the LED ON
                break;
            default:
                break;
        }
    }
}
```

8. Build the project by choosing **Build > Build Project** or pressing **[Shift][F6]**. After the project is built without errors and warnings, program (**[Ctrl][F5]**) this project onto the PSoC 6 BLE using KitProg.
9. Open BCP from **Start > All Programs > Cypress > Bridge Control Panel <version> > Bridge Control Panel <version>**.
10. Select **KitProg2/<serial number>** under **Connected I2C/SPI/RX8 Ports**, as shown in [Figure 8-8](#). Select the protocol configuration and type in the command as shown in [Figure 8-8](#). Refer BCP help topic for SPI command formats. Click on the “Send” radio button to send the command from BCP.

Figure 8-8. Connecting to Kitprog2 USB-SPI Bridge in BCP



**Expected Output:** Sending a command word of 0x01, turns LED5 ON and a command word of 0x00 turns LED5 OFF.

## 9. Developing Applications for PSoC 5LP



The KitProg2 is implemented using a PSoC 5LP device. You can also use the PSoC 5LP as a mixed-signal system-on-chip device to build your own custom projects. For example, the PSoC 5LP on the kit can be reprogrammed to act as a function generator for the kit. Refer to the application note [AN69133 – PSoC 3 / PSoC 5LP: Easy Waveform Generation with the WaveDAC8 Component](#) for details on how to create waveforms using a PSoC 5LP device.

Two types of projects can be created for a PSoC 5LP that runs KitProg2: Custom (Bootloadable) Application and Normal. Custom application projects can be bootloaded into the PSoC 5LP using the USB connection from a PC without any specialized hardware. To program normal projects, you will require a [MiniProg3](#). You also need to populate the PSoC 5LP programming header on the development kit. For the PSoC 4 S-Series Pioneer Kit, this header is marked J11. See the respective kit guide for more information on the PSoC 5LP programming header. Go to section [9.2 Building a Normal Project for PSoC 5LP on page 67](#) for details on creating a normal project for PSoC 5LP.

Custom applications for KitProg2 are developed using the concept of dual image bootloading. To learn more about the bootloading concept, refer to the application note [AN73854 – PSoC 3, PSoC 4, and PSoC 5LP: Introduction to Bootloaders](#).

The following sections provide step by step directions to build a Custom Application and a Normal project for KitProg2.

### 9.1 Building a Custom Bootloadable Application for KitProg2

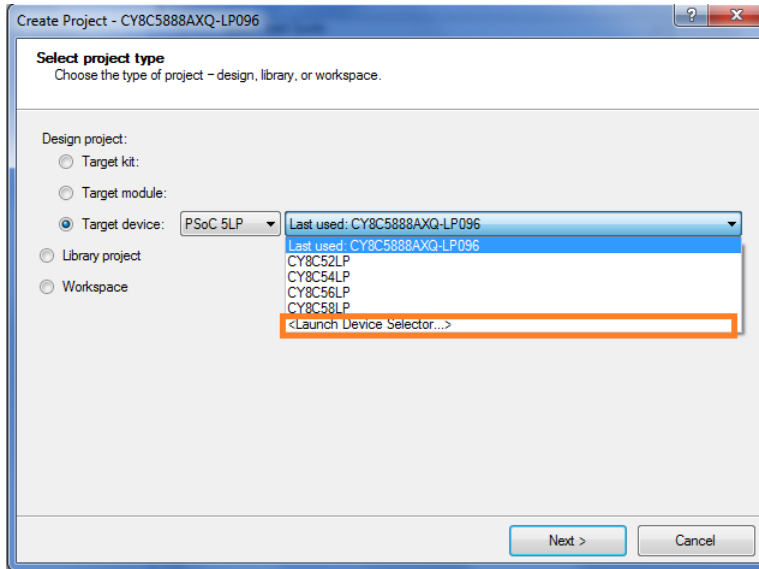
Custom applications developed for the PSoC 5LP are programmed to the kit using the KitProg2 bootloader. Therefore, a bootloadable project should first be created. An example of a custom application is provided as a compressed archive *KitProg2\_Custom\_App.zip* in the PSoC Programmer installation folder under `Examples\Misc\KitProg2_Custom_App\`. This example demonstrates an LED with a breathing effect and also has the feature to switch between KitProg2 and custom application using the mode switch.

To build a custom application for the PSoC 5LP, follow this procedure:

1. In PSoC Creator, choose **File > New > Project** and select **Target device**; select **<Launch Device Selector...>** from the drop-down list as shown in [Figure 9-1](#)

**Note:** The custom application must provide a means to switch back to KitProg2 mode, otherwise the programming capability will be lost unless KitProg2 firmware is re-bootloaded.

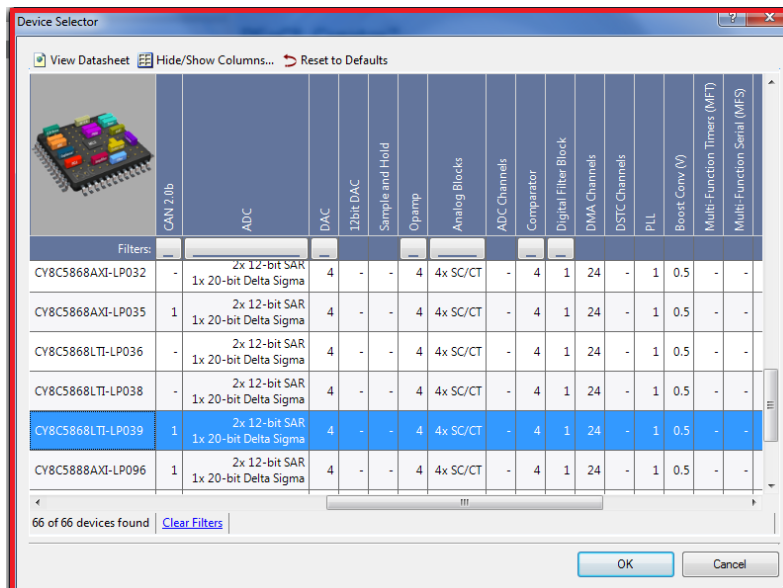
Figure 9-1. Open New Project in PSoC Creator



2. Select **CY8C5868LTI-LP039**, as shown in [Figure 9-2](#). Click **OK** and click **Next**.

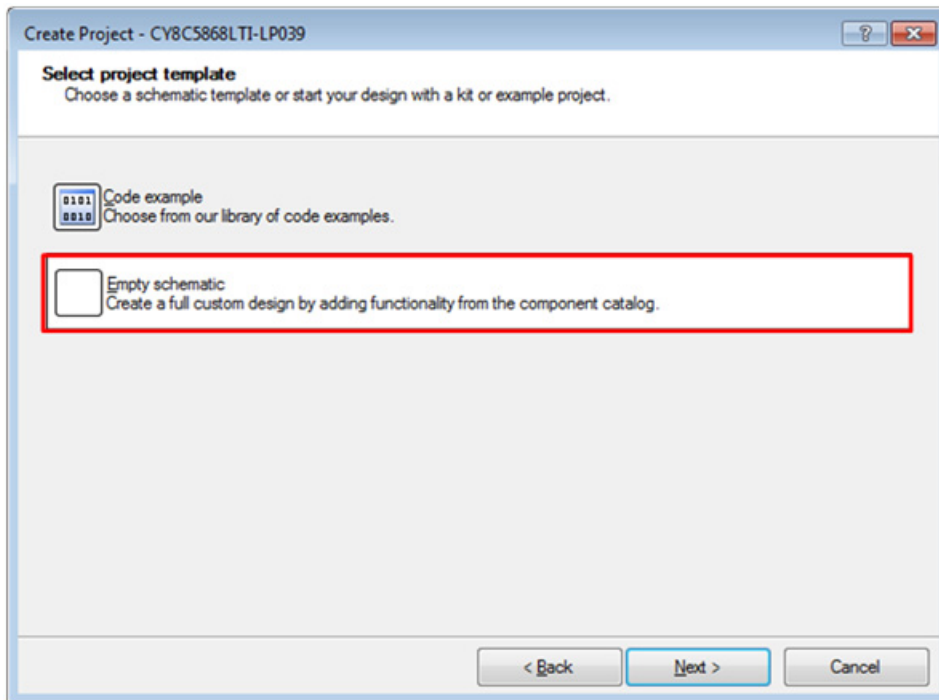
**Note:** In PSoC Creator 3.1 or earlier, you must either set the **Application Type** as **Bootloadable** in the New Project window under the Advanced section, or you can change it after project creation by selecting **Project > Build Settings** and clicking **<Project Name> > Application Type > Bootloadable**. Beginning with PSoC Creator 3.2, the **Application Type** option is removed from the New Project window and the Build Settings menu. PSoC Creator 3.2 and later versions automatically recognizes the application type from the TopDesign schematic.

Figure 9-2. Select Device in PSoC Creator



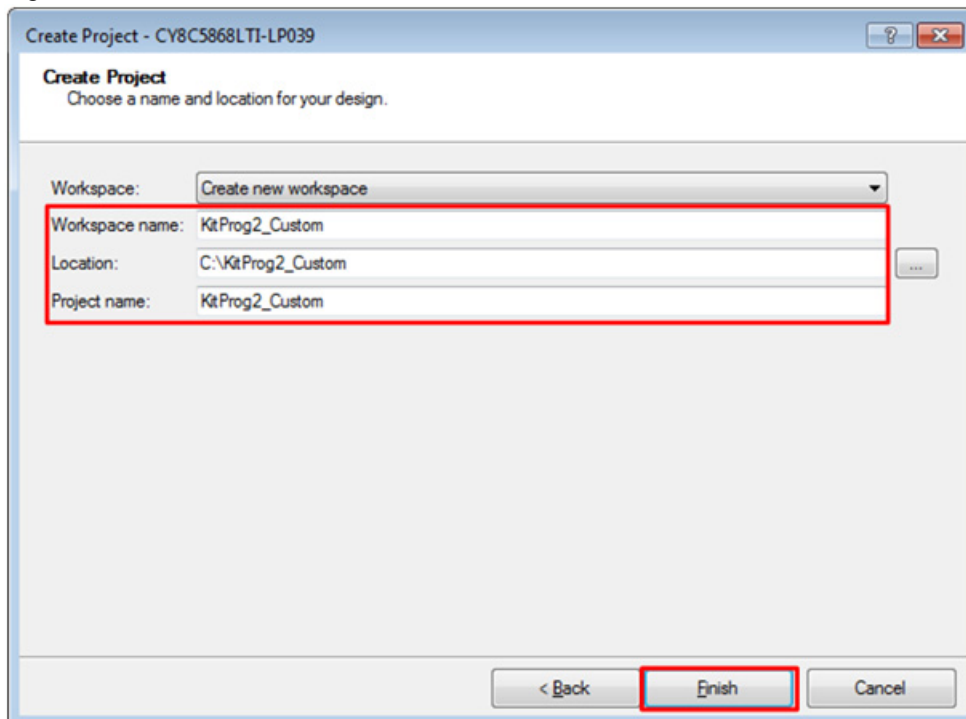
3. Choose **Empty schematic** in the **Select project template** dialog, as shown in [Figure 9-3](#). Click **Next**.

Figure 9-3. Select Empty Schematic



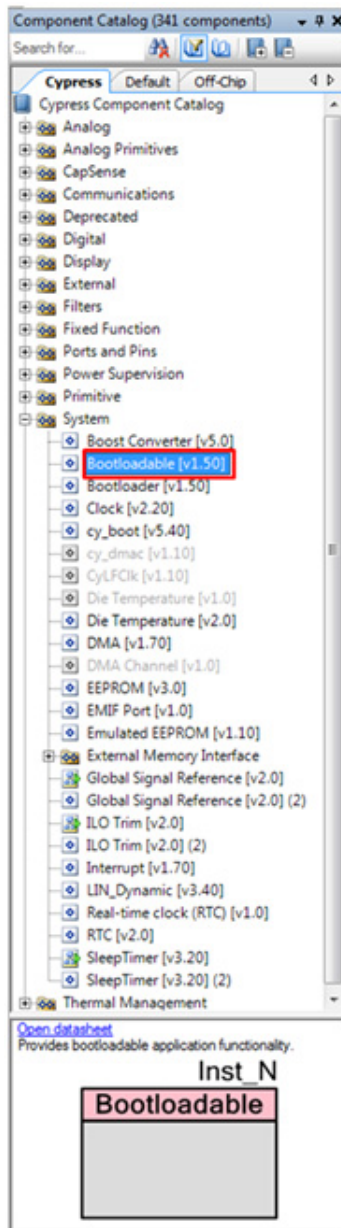
4. In the **Create Project** dialog, choose the workspace name, location, and project name ([Figure 9-4](#)). Click **Finish**.

Figure 9-4. Choose Name and Location



- Navigate to the Schematic view and drag and drop a Bootloadable Component (see Figure 9-5) on the TopDesign.

Figure 9-5. Bootloadable Component in Component Catalog



- All custom applications developed for the PSoC 5LP should be based on the KitProg2 bootloader .hex file, which is programmed onto the kit. Therefore, you need to provide the location of the bootloader .hex file inside the custom application project.

The bootloader .hex file is included in the compressed archive *KitProg2\_Custom\_App.zip* in the PSoC Programmer installation folder under `Examples\Misc\KitProg2_Custom_App\`. They are also present in Kit installation directory at `<Install_Directory>\<Kit_Name>\<version>\Firmware\Programmer\KitProg2_Bootloader\`.

Extract the Bootloader folder from the archive.

- Set the dependency of the Bootloadable Component by selecting the **Dependencies** tab in the configuration window and clicking the **Browse** button, as shown in Figure 9-6. Select the *KitProg2\_Bootloader.hex* (see Figure 9-7) extracted in step 6 and click **Open**.

**Note:** The user should copy the *.hex* and *.elf* files into their custom project folder and refer to them from that location. The *KitProg2\_Bootloader.elf* is selected automatically if it is available with the same name in the same path. Ensure that both *.hex* and *.elf* files exist in the same folder with the same name.

Figure 9-6. Configuration Window of Bootloadable Component

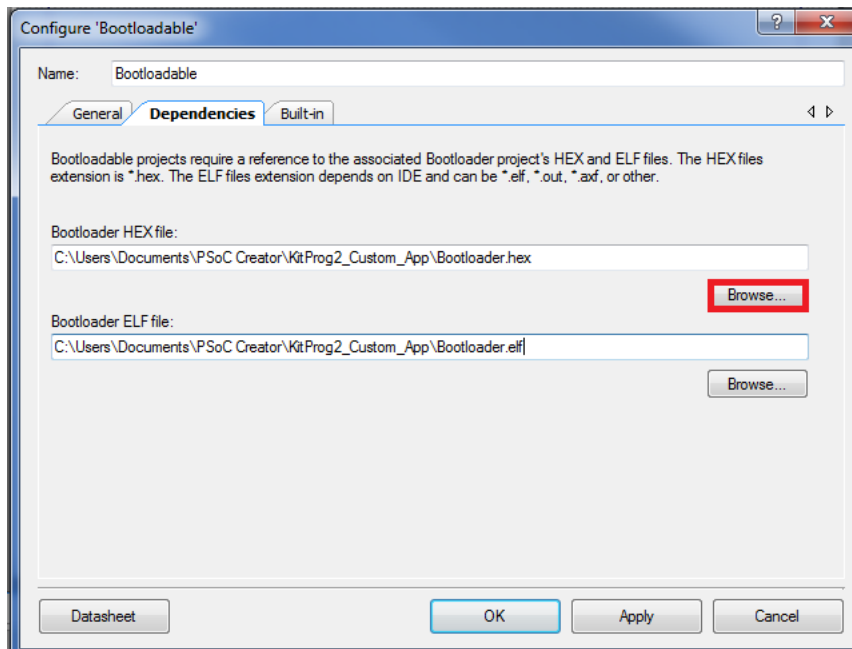
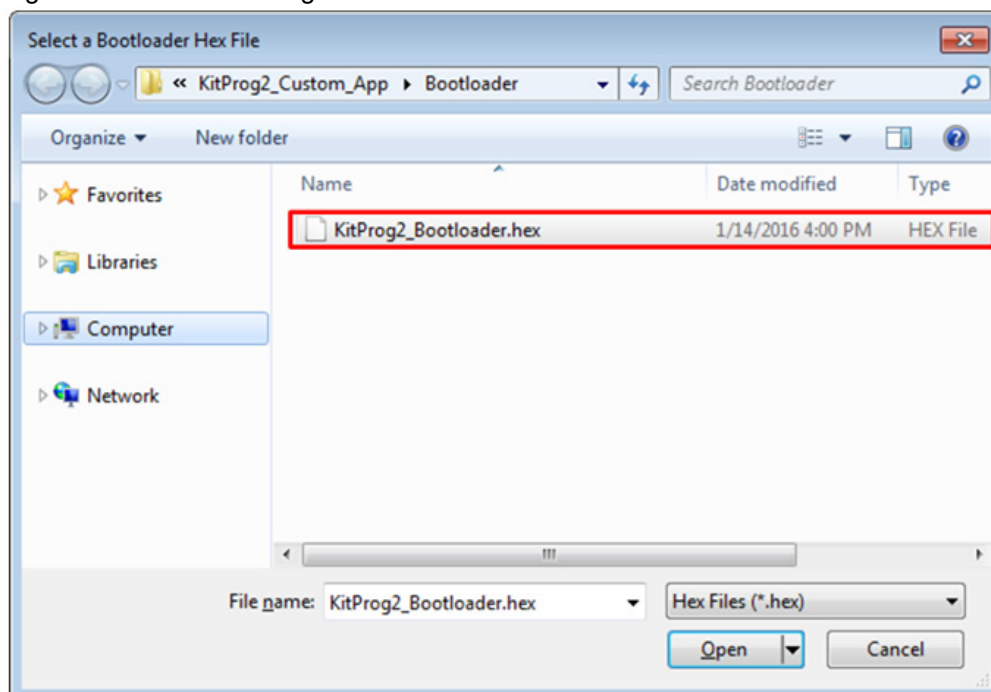
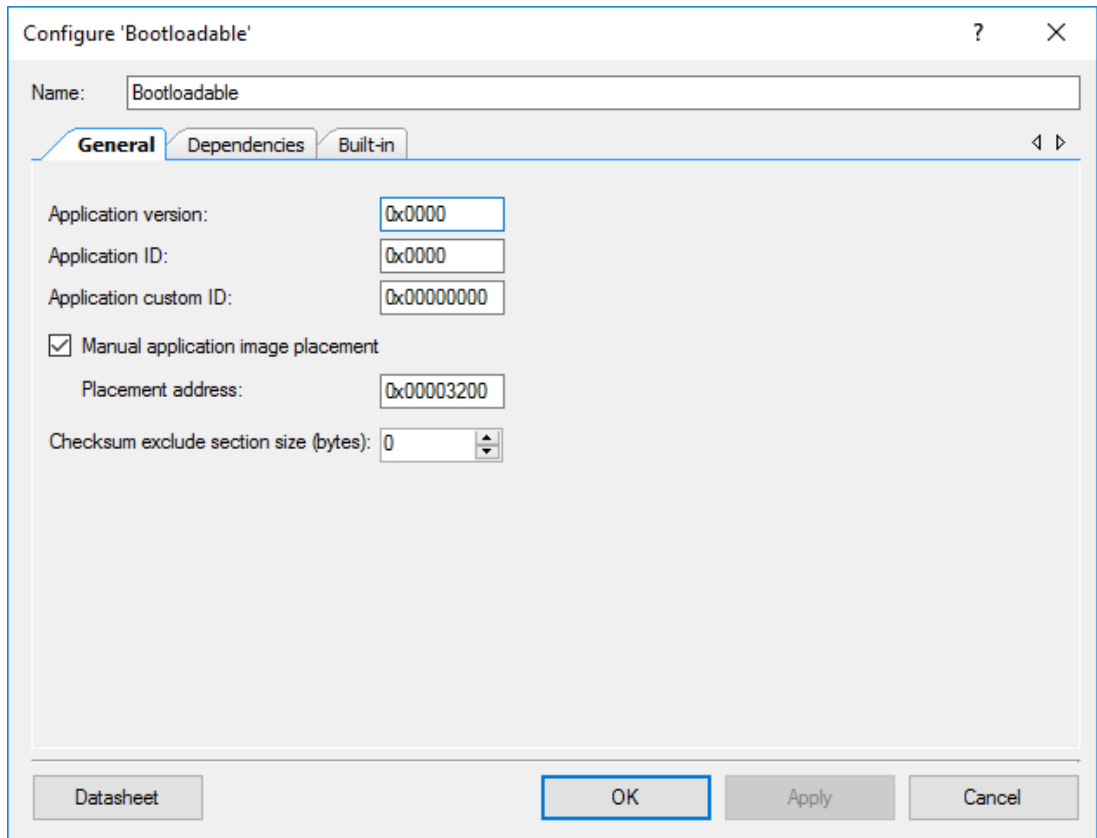


Figure 9-7. Select KitProg2 Bootloader Hex File.



- In the General tab, check the Manual application image placement checkbox and set the Placement address as '0x00003200', as shown in [Figure 9-8](#).

Figure 9-8. Bootloadable Component - General Tab



- Develop your custom project. An example of a custom application is provided as a compressed archive *KitProg2\_Custom\_App.zip* in the PSoC Programmer installation folder under `Examples\Misc\KitProg2_Custom_App\`. This example demonstrates an LED with a breathing effect and also has the feature to switch between KitProg2 and custom application using the mode switch.



- Ensure that the `<project name>.cydwr` **System** setting of the bootloadable project and the `KitProg2_Bootloader` project is the same. [Figure 9-9](#) shows the `KitProg2_Bootloader.cydwr` **System** settings.

Figure 9-9. KitProg2 Bootloader System Settings

Option	Value
Configuration	
Device Configuration Mode	Compressed
Enable Error Correcting Code (ECC)	<input type="checkbox"/>
Instruction Cache Enabled	<input checked="" type="checkbox"/>
Enable Fast IMO During Startup	<input checked="" type="checkbox"/>
Unused Bonded IO	Allow but warn
Heap Size (bytes)	0x80
Stack Size (bytes)	0x0800
Include CMSIS Core Peripheral Library Files	<input checked="" type="checkbox"/>
Programming/Debugging	
Debug Select	GPIO
Enable Device Protection	<input type="checkbox"/>
Embedded Trace (ETM)	<input checked="" type="checkbox"/>
Use Optional XRES	<input type="checkbox"/>
Operating Conditions	
Variable VDDA	<input type="checkbox"/>
VDDA (V)	5.0
VDDD (V)	5.0
VDDIO0 (V)	5.0
VDDIO1 (V)	5.0
VDDIO2 (V)	5.0
VDDIO3 (V)	5.0
Temperature Range	-40C - 85/125C

- Build the project in PSoC Creator by choosing **Build > Build Project** or pressing **[Shift] [F6]**.
- To program the project onto the PSoC 5LP device, open the Bootloader Host tool, which is available in PSoC Creator. Choose **Tools > Bootloader Host**, as shown in [Figure 9-10](#). Alternatively, the Bootloader Host tool can be accessed by going to **Start > All Programs > Cypress > PSoC Creator 3.3 > Bootloader Host**, as shown in [Figure 9-11](#).

Figure 9-10. Open Bootloader Host Tool in PSoC Creator

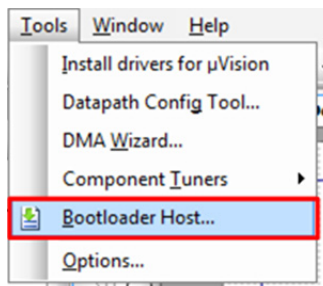
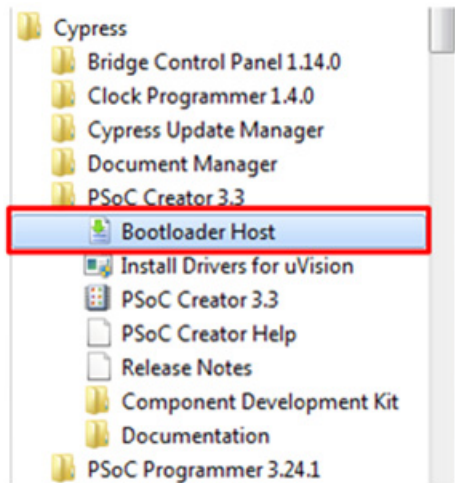
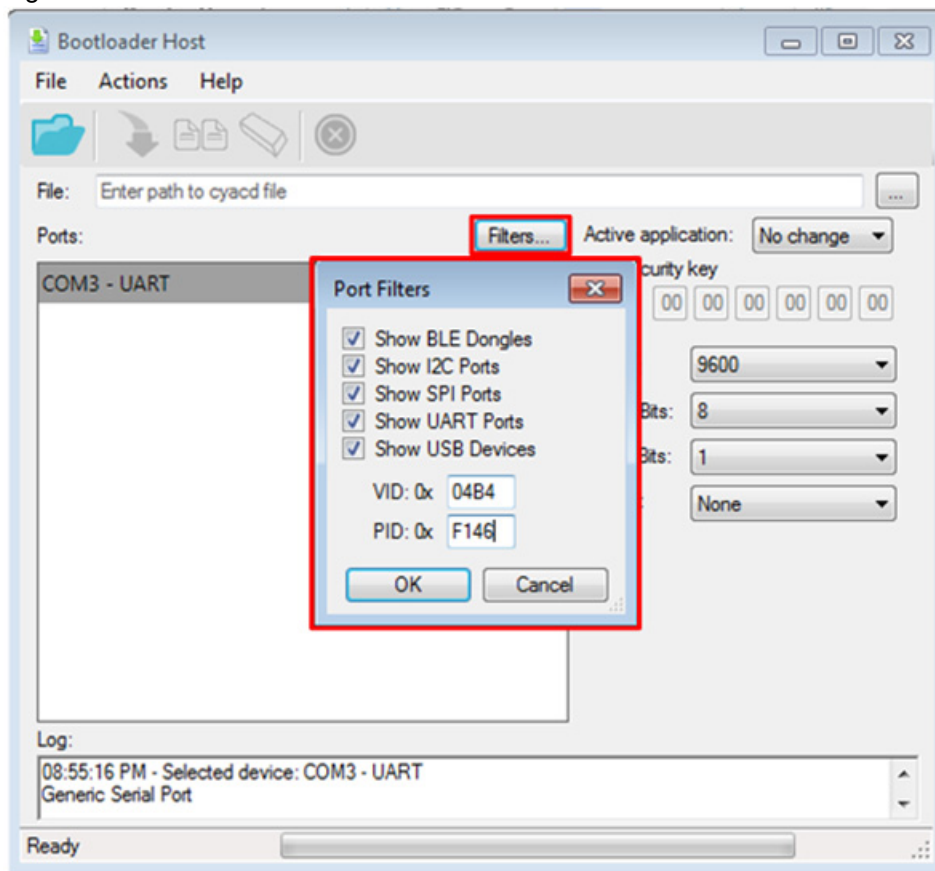


Figure 9-11. Open Bootloader Host Tool in All Programs



13. Press and hold the mode switch while connecting the kit to the computer. If the switch is pressed for more than 100 ms, the PSoC 5LP enters the bootloader. The amber status LED will start blinking to indicate that PSoC 5LP entered bootloader mode.
14. In the Bootloader Host tool, click **Filters** and add a filter to identify the USB device. Ensure that the check box for **Show USB Devices** is enabled. Set VID as **04B4**, PID as **F146**, and click **OK**, as shown in Figure 9-12.

Figure 9-12. Port Filters Tab in Bootloader Host Tool



15. In the Bootloader Host tool, click the **Open File** button (Figure 9-13) to browse to the location of the bootloadable file (\*.cyacd), as shown in Figure 9-14. This file is present in the project directory. The .cyacd file is available in the following path:

```
<Project Directory>\<Project Name.cydsn>\CortexM3\<Compiler Name and Version>\<Debug> or <Release>\<Project Name>_2.cyacd
```

Note that there are 2 cyacd files in the project directory. *<Project\_Name>\_1.cyacd* is the first application (in this case the KitProg2 application) and *<Project\_Name>\_2.cyacd* is the second application (in this case the custom application). Therefore, we want to select *<Project\_Name>\_2.cyacd* to bootload the custom application.

The “Active application” selection shown in Figure 9-13 is used to determine which application will start once bootloading has completed. In this case, since we have selected Image 2, the custom application will run once bootloading finishes.

Figure 9-13. Open Bootloadable File in Bootloader Host Tool

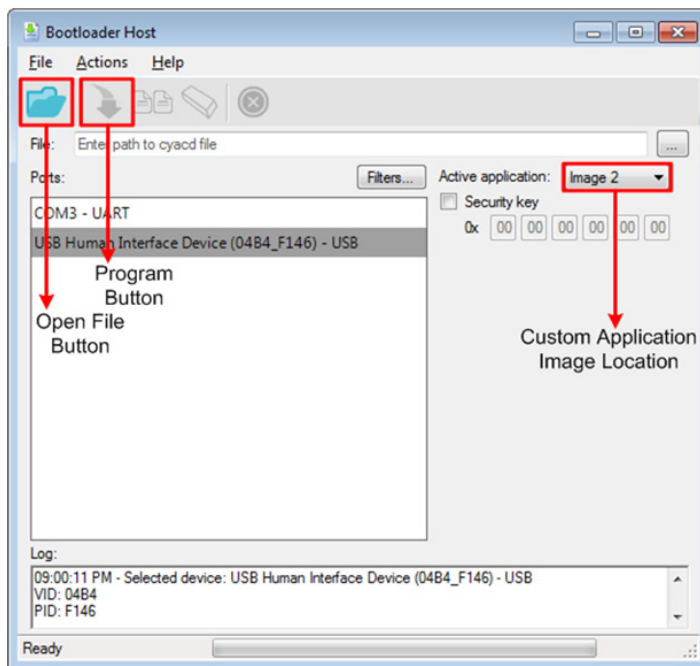
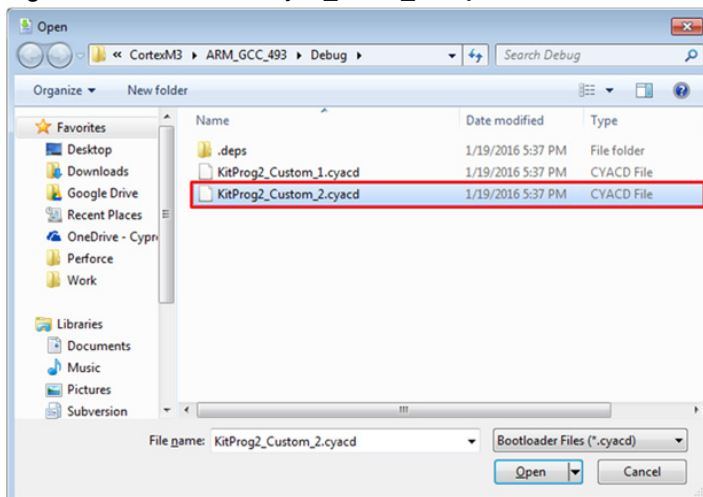


Figure 9-14. Select <Project\_Name\_2> .cyacd File from Bootloader Host Tool



16. Select the **USB Human Interface Device (04B4\_F146) - USB** in the **Ports** list and click the **Program** button (Figure 9-13) in the Bootloader Host tool to program the device.
17. If the bootload is successful, the log displays “Programming Finished Successfully”; otherwise, it displays “Failed” and a reason for the failure.

**Notes:**

- The PSoC 5LP pins are connected to the PSoC 5LP GPIO header. These pins are selected to support high-performance analog and digital projects. See section [A.1 Pin Assignments on page 78](#) for pin information.
- Take care when allocating the PSoC 5LP pins for custom applications. For example, P3[2]–P3[3] are dedicated for programming the PSoC 4000S in CY8CKIT-041-40XX. Refer to the respective kit schematics before allocating the pins.
- When a custom bootloadable project is the active application on the PSoC 5LP, the initial capability of the PSoC 5LP to act as a programmer, USB-UART Bridge or USB-I2C Bridge or USB-SPI Bridge is not available. To recover this functionality, switch the active application back to the KitProg2 image.
- The status LEDs do not function unless they are implemented and used by the custom project.

For additional information on bootloaders, refer to the [AN73503 – USB HID Bootloader for PSoC 3 and PSoC 5LP](#).

## 9.2 Building a Normal Project for PSoC 5LP

A normal project is a new project created for the PSoC 5LP device on the PSoC 4 S-Series Pioneer board. Here, the entire flash of the PSoC 5LP is programmed, overwriting all bootloader and programming code. To recover the programmer, USB-UART Bridge or USB-I2C or USB-SPI Bridge functionality, reprogram the PSoC 5LP device with the factory-set *KitProg2.hex* file, which is shipped with the kit installer.

This advanced functionality requires a MiniProg3 programmer, which is not included with this kit. The MiniProg3 can be purchased from [www.cypress.com/go/CY8CKIT-002](http://www.cypress.com/go/CY8CKIT-002). In addition, the PSoC 5LP programming header (PSoC 5LP PROG) on the kit needs to be populated (refer to the kit’s Bill of Materials to order the part), to connect the MiniProg3 for programming and debugging the PSoC 5LP device.

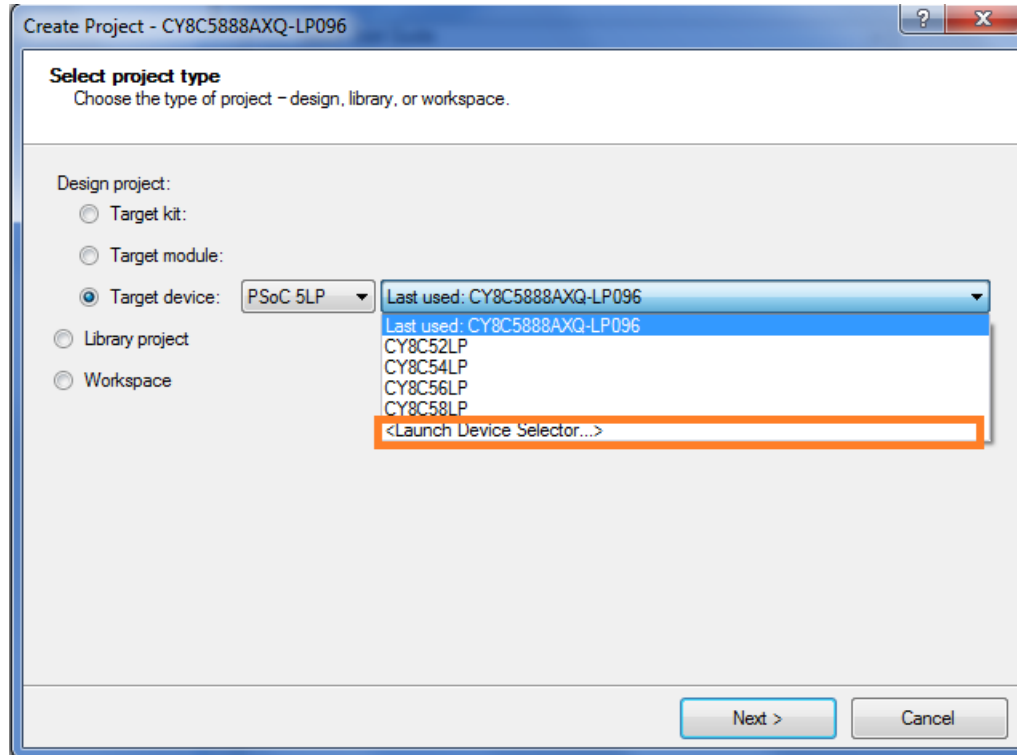
The *KitProg2.hex* file is available at the following location:

```
<Install_Directory>\<Name_of_the_Kit>\<version>\Firmware\  
Programmer\KitProg2\KitProg2.hex
```

To build a normal project for the PSoC 5LP, follow these steps:

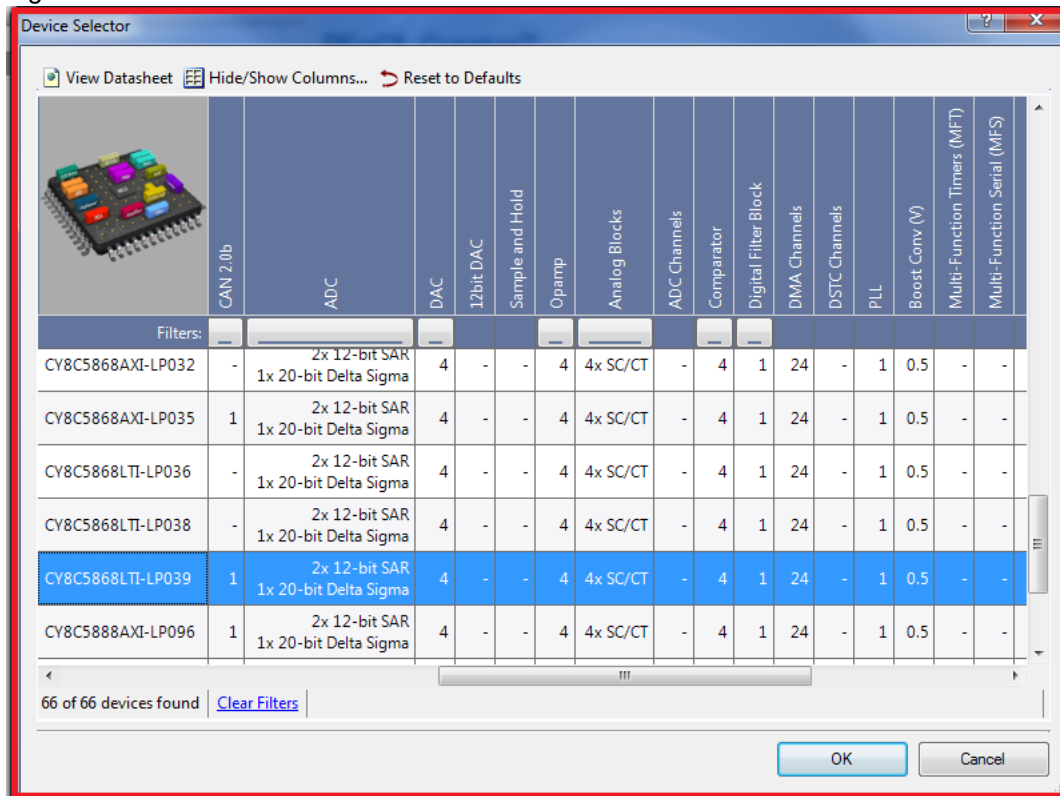
1. In PSoC Creator, choose **File > New > Project** and select **Target device**; select **<Launch Device Selector...>** from the drop-down list and click **Next**. See [Figure 9-15](#).

Figure 9-15. Create New Project in PSoC Creator



2. Select **CY8C5868LTI-LP039**, as shown in [Figure 9-16](#). Click **OK**.

Figure 9-16. Select the Device

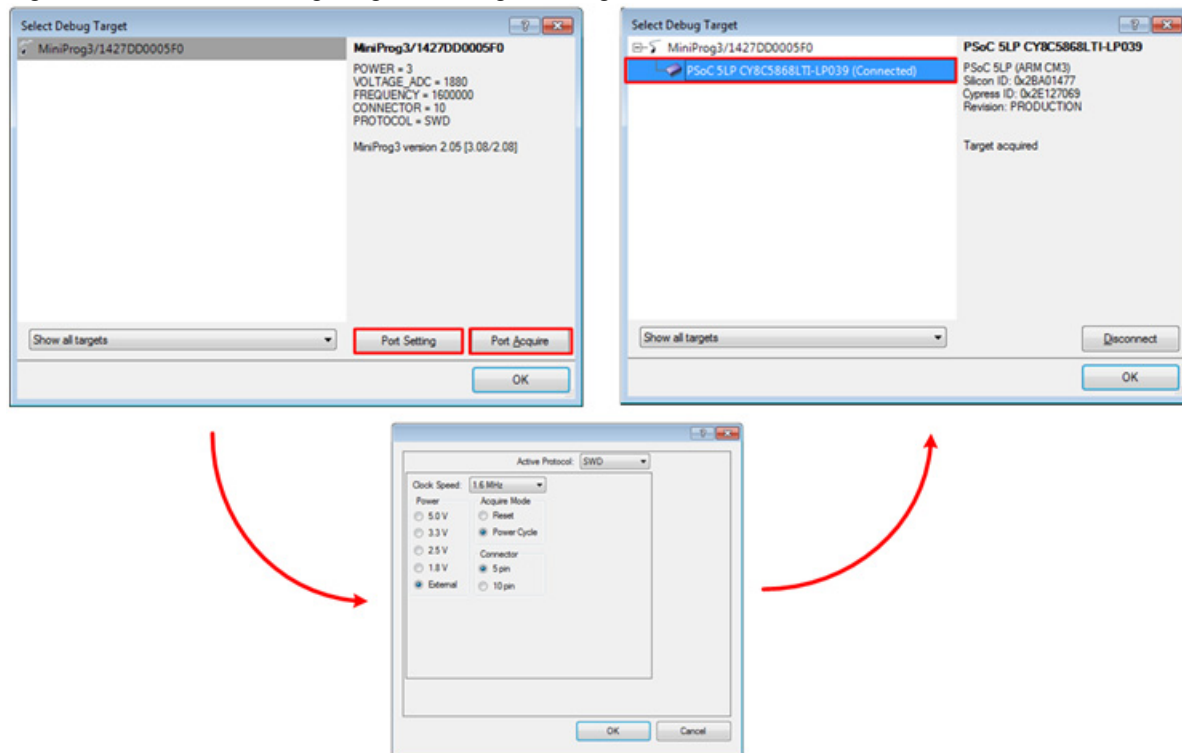


3. Develop your custom project.
4. Build the project in PSoC Creator by choosing **Build > Build Project** or pressing **[Shift] [F6]**.
5. Connect the MiniProg3 to the onboard PSoC 5LP Programming header J11 (which needs to be populated).

6. To program the PSoC 5LP with PSoC Creator, choose **Debug > Program** or press **[Ctrl] [F5]**. If the **Select Debug Target** window appears and shows MiniProg3 and the selected device in the project under it (CY8C5868LTI-LP039), select the device and click **Connect** to acquire and program.

If the PSoC device is not available, click the **Port Setting** button. Set **Active Protocol** to 'SWD', **Acquire Mode** to 'Power Cycle', and **Connector** to either 5 pin or 10 pin depending on the kit. Then, click the **Port Acquire** button for the PSoC 5LP device to appear. See [Figure 9-17](#).

Figure 9-17. Select Debug Target for Programming



#### Notes:

- The PSoC 5LP programming header is not populated.
- The PSoC 5LP pins are brought to the PSoC 5LP GPIO header. These pins are selected to support high-performance analog and digital projects. See [A.1 Pin Assignments on page 78](#) for pin information.
- Take care when allocating the PSoC 5LP pins for custom applications. For example, P3[2]–P3[3] are dedicated for programming the PSoC 4000S in CY8CKIT-041-40XX. Refer to the respective kit schematics before allocating the pins.
- When a normal project is programmed onto the PSoC 5LP, the initial capability of the PSoC 5LP to act as a programmer, USB-UART Bridge or USB-I2C Bridge or USB-SPI Bridge is not available.
- The status LEDs do not function unless they are implemented and used by the custom project.

# 10. Troubleshooting the KitProg2



This section explains the methods to troubleshoot the KitProg2 and recover the KitProg2 firmware if you modified it.

## 10.1 KitProg2 Status LED Indication

The KitProg2 status LEDs on the development kit indicate the status of the KitProg2 operation using different blink rates. [Table 10-1](#) shows the KitProg2 LED indication and the corresponding status of the KitProg2.

Table 10-1. Meaning of KitProg2 LED Indications

User Indication			Scenario	Action Required by User
Amber LED	Green LED	Red LED		
ON	OFF	OFF	USB enumeration is successful. KitProg2 is in PPCOM programming mode.	PSoC Creator, PSoC Programmer, BCP, and any serial port terminal program can use the kit functions. Normal operation of your application on the target device occurs in this mode.
OFF	OFF	OFF	USB enumeration is unsuccessful.	This indicates that the USB enumeration was unsuccessful. It may happen if the kit is not powered from the USB host. Verify the USB cable and check if PSoC Programmer is installed on the PC.
ON	Blinking Frequency = 8 Hz	OFF	Programming of the target device is currently in process.	No action is required.
ON	ON	OFF	Programming of target successful	No action is required.
ON	OFF	ON	Programming of target not successful	Use correct hex file with respect to the device on board
OFF	OFF	OFF	KitProg2 is in mass storage programming mode/CMSIS-DAP programming mode	Open KitProg2 drive. Drag and drop a hex file that corresponds to the target device to the drive window to start programming. Normal operation of your application on the target device occurs in this mode.



Table 10-1. Meaning of KitProg2 LED Indications (*continued*)

User Indication			Scenario	Action Required by User
Amber LED	Green LED	Red LED		
OFF	8 Hz	OFF	Programming of the target device is currently in process in Mass storage Mode.	No action is required.
OFF	ON	OFF	Programming of the target device is complete and successful in mass storage mode. Note that this is applicable only in drag-and-drop programming. The green LED will not turn ON if the programming is through PSoC Creator or PSoC Programmer.	No action is required. Normal operation of your application on the target device occurs in this mode.
Blinking Frequency = 1 Hz	OFF	OFF	KitProg2 is in bootloader mode.	In this mode, you can bootloader a new version of your custom application firmware.
8 Hz (Blinking)	User defined	User Defined	Custom application mode	No Action required
ON	Blinking Frequency = 15.0 Hz	OFF	SWD or I2C operation is in progress. The kit's COM port connect and disconnect event (only one blink).	In PSoC Programmer, watch the log window for status messages for SWD operations. In the BCP, the LED blinks on I2C command requests. In BCP or any other serial port terminal program, the kit's COM port will appear when the port is connected and it will disappear when the port is disconnected.

**Note:** There is another category of Kits known as prototyping Kits which have single button and a single LED based KitProg2 System. To enter into various modes below points should be noted:

1. When the kit is in KitProg2 mode, the Amber LED will be on.
2. When the kit is in Mass Storage/CMSIS DAP mode, the Amber LED is turned off. To reach this mode, press and release the mode switch provided on the prototyping kit in less than 2 seconds.

**Note:** In 1.04 KitProg2 version, Amber LED shows breathing effect in Mass Storage or CMSIS DAP Mode

3. When the kit is in Bootloader mode, the Amber LED shows a blinking effect. To reach this mode, hold down the mode switch and insert the kit into a USB port.

**Note:** The various modes and their representation in terms of LEDs with different colors are not supported in these categories of kits eg. CY8CIT-146 PSoC 4200DS Prototyping Kit.

**Note:** The BCP software cannot connect to the KitProg2, if the KitProg2 firmware version is outdated. See [Updating the KitProg2 Firmware on page 17](#) to update the KitProg2 firmware.

**Note:** The programming/debugging function and USB-I2C Bridge/USB-SPI Bridge function of the KitProg2 are mutually exclusive functions and cannot be used together. Therefore, to use one function the other function should be disconnected. For instance, to program the device while using the USB-I2C Bridge/USB-SPI Bridge in BCP, either close BCP or disconnect the USB-I2C Bridge/USB-SPI Bridge. The USB-UART Bridge function of the KitProg2, however, can run in parallel to both programming/debugging and USB-I2C Bridge/USB-SPI Bridge functions. USB-I2C Bridge and USB-SPI Bridge functionality cannot be used simultaneously.

## 10.2 PSoC 5LP Factory Program Restore Instructions

### 10.2.1 PSoC 5LP is Programmed with a Custom Application

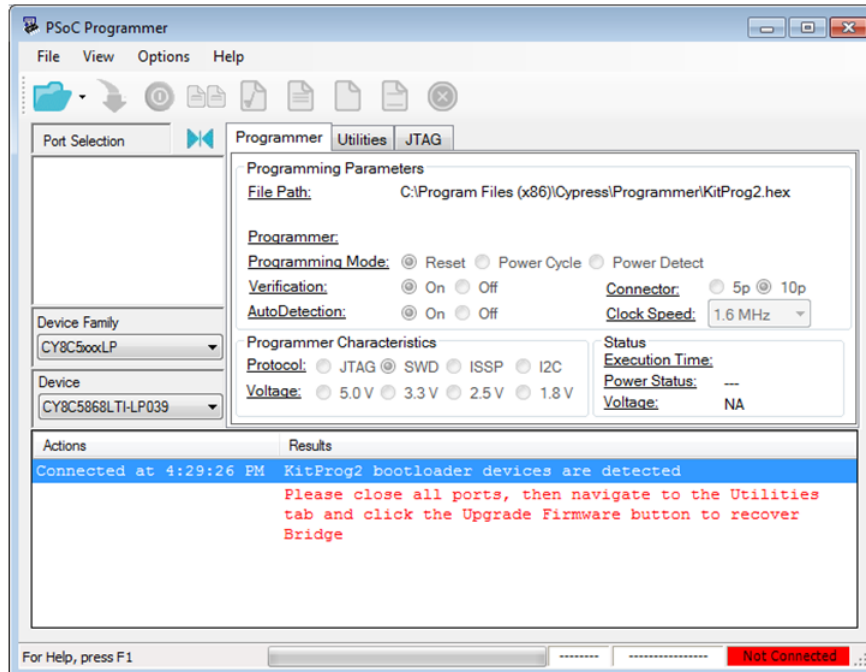
Reprogramming the PSoC 5LP device with a new flash image in the KitProg2 area of flash (i.e. application area 1) will forfeit the ability to use the PSoC 5LP device as a programmer/debugger for the kit. See section [10.2.1.1 Restore PSoC 5LP Factory Program Using PSoC Programmer on page 74](#), for details on restoring the KitProg2.

**Note:** This method cannot be used to recover the KitProg2 if the PSoC 5LP was reprogrammed using a MiniProg3. See section [10.2.2 Restore PSoC 5LP KitProg2 using MiniProg3 on page 76](#) if you want to recover the KitProg2 functionality using a MiniProg3.

### 10.2.1.1 Restore PSoC 5LP Factory Program Using PSoC Programmer

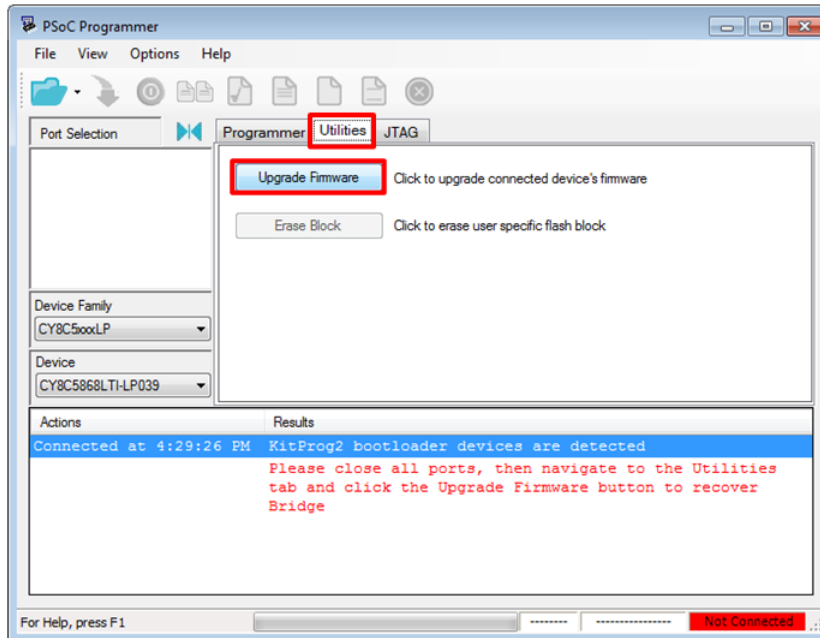
1. Launch PSoC Programmer from **Start > Cypress > PSoC Programmer <version> > PSoC Programmer <version>**.
2. Configure the Kit in bootloader mode. To do this, while pressing the mode switch, connect the Kit to the computer using the included USB cable (USB Standard-A to Micro-B). This puts the PSoC 5LP into bootloader mode, which is indicated by the blinking amber status LED.
3. The following message appears in the PSoC Programmer **Results** window (see [Figure 10-1](#)): “KitProg2 Bootloader devices are detected”.

Figure 10-1. PSoC Programmer Results Window



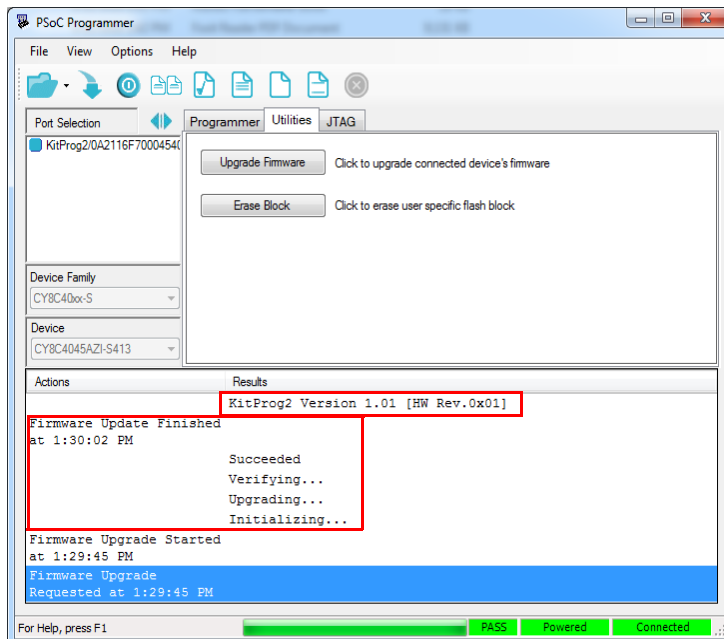
- Switch to the **Utilities** tab in PSoC Programmer and click the **Upgrade Firmware** button, as shown in [Figure 10-2](#). Unplug all other PSoC programmers (such as MiniProg3 and DVKProg) from the PC before clicking the **Upgrade Firmware** button.

Figure 10-2. Upgrade Firmware



- After programming is completed, the message "Firmware Update Finished at <time>" appears, and PASS message is indicated on the status bar, as shown in [Figure 10-3](#).

Figure 10-3. Firmware Update Completed



- The factory program is now successfully restored on the PSoC 5LP. It can be used as the programmer/debugger for the PSoC 4000S device.

## 10.2.2 Restore PSoC 5LP KitProg2 using MiniProg3

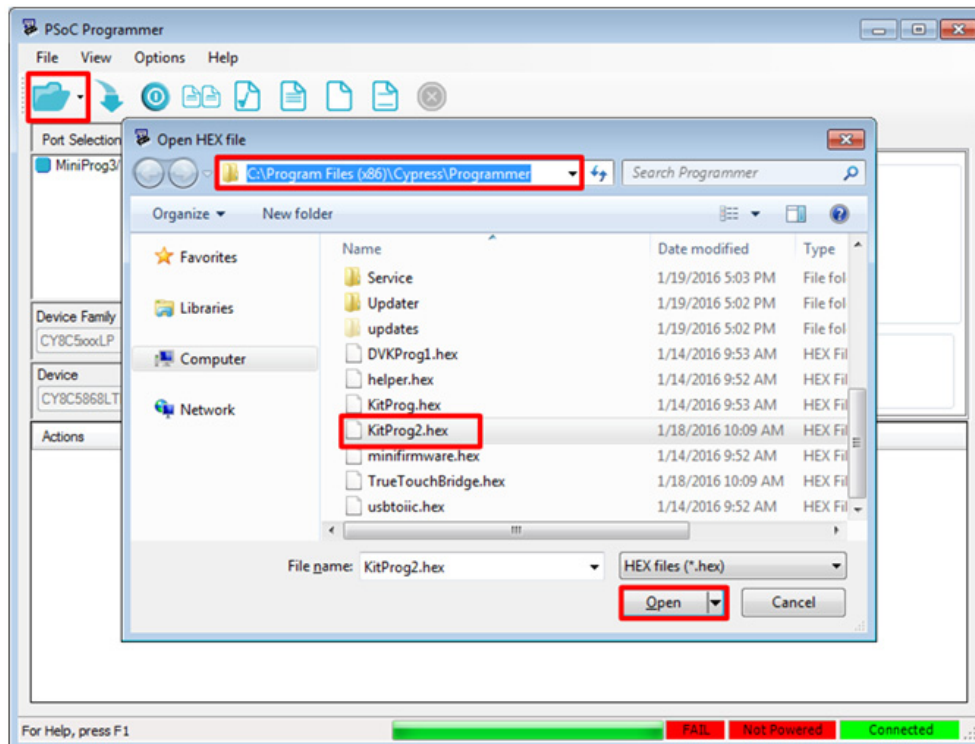
This section explains the method to reprogram the PSoC 5LP using a MiniProg3 to recover the KitProg2 functionality. This method must be used to recover the KitProg2 if the PSoC 5LP was completely reprogrammed. Note that this method of restoring KitProg2 will erase any custom applications loaded earlier.

1. Launch PSoC Programmer from **Start > Cypress > PSoC Programmer <version> > PSoC Programmer <version>**.
2. Connect the MiniProg3 to the PC. Connect the 5-pin or 10-pin connector (depending on the kit) of the MiniProg3 to the onboard PSoC 5LP programming header.

**Note:** This header is not populated by default. You will need to populate it to connect the MiniProg3.

3. Select **MiniProg3** from the **Port Selection** list in PSoC Programmer on your PC.
4. Using the **File > Open** menu or the **File Load** icon, load the *KitProg2.hex* file, which is installed with the kit software, as shown in Figure 10-4. The default location for this file is: C:\Program Files (x86)\Cypress\Programmer\KitProg2.hex.

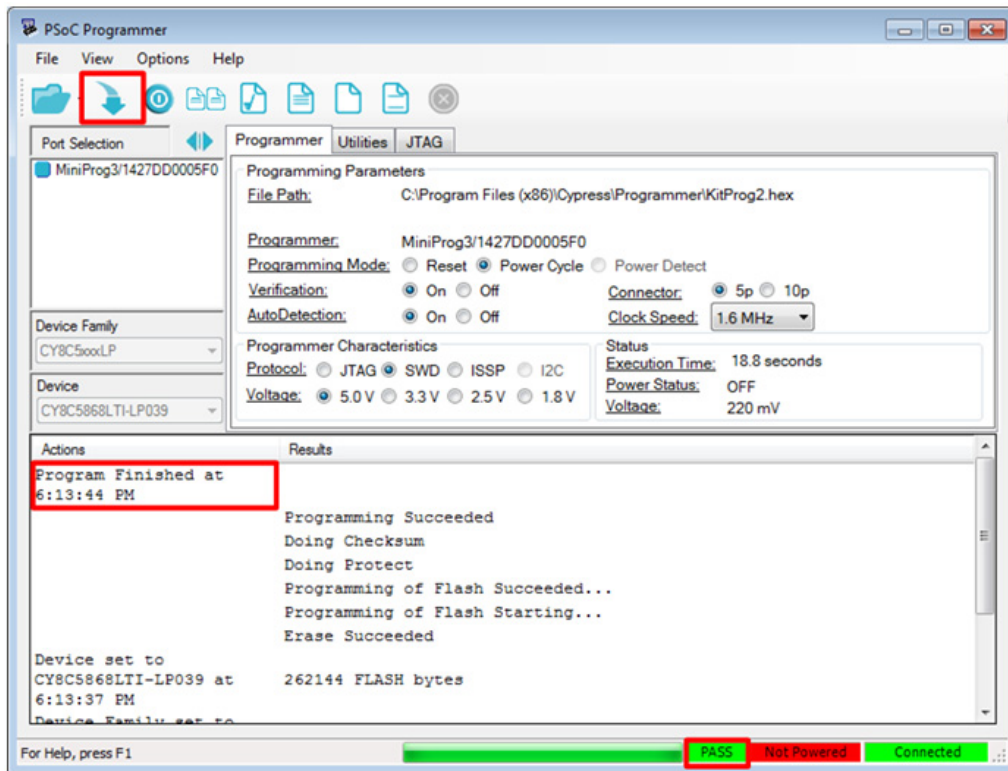
Figure 10-4. Select the *KitProg2.hex* File to Program the PSoC 5LP



5. Select the **Power Cycle** option for Programming Mode, **5.0 V** for voltage, **10p** (or 5p, if applicable) for Connector, and **SWD** for Protocol.
6. Click the **Program** button or **File > Program** to program the PSoC 5LP device.

- After programming is complete, the “Program Finished at <time>” message is displayed, and PASS is indicated on the status bar, as shown in [Figure 10-5](#).

Figure 10-5. Firmware Programming Completed



# A. Appendix



## A.1 Pin Assignments

### A.1.1 PSoC 5LP GPIO and Custom Application Header (J8 and J11) for CY8CKIT-041-40XX and CY8CKIT-041-41XX

J8					
Pin	PSoC 5LP Signal	PSoC 5LP Description	Pin	PSoC 5LP Signal	PSoC 5LP Description
J8_01	PSoC 5LP_VDD	VDD	J8_02	N.C	No Connect
J8_03	P15[1]	SPI MOSI	J8_04	P0[1]	CUSTOM
J8_05	P15[2]	SPI SCLK	J8_06	P12[0]	I2C SCL
J8_07	P15[3]	SPI SSEL	J8_08	P3[0]	CUSTOM
J8_09	P12[5]	SPI MISO	J8_10	P12[1]	I2C SDA
J8_11	P3[4]	CUSTOM	J8_12	P3[5]	CUSTOM
J8_13	P12[7]	UART RX	J8_14	P12[6]	UART TX
J8_15	P3[6]	CUSTOM	J8_16	GND	GND
J11					
Pin	PSoC 5LP Signal	PSoC 5LP Description	Pin	PSoC 5LP Signal	PSoC 5LP Description
J11_01	P0[2]	CUSTOM	J11_02	PSoC 5LP_VBUS	VBUS
J11_03	P0[3]	CUSTOM	J11_04	GND	GND
J11_05	P0[7]	CUSTOM	J11_06	PSoC 5LP_XRES	XRES
J11_07	P1[6]	INT_PIN	J11_08	PSoC 5LP_SWCLK	SWD CLK
J11_09	P15[4]	SUSPEND	J11_10	PSoC 5LP_SWDIO	SWD IO

### A.1.2 PSoC 5LP GPIO and Custom Application Header (J16 and J11) for CY8CKIT-048

J16					
Pin	PSoC 5LP Signal	PSoC 5LP Description	Pin	PSoC 5LP Signal	PSoC 5LP Description
J16_01	PSoC 5LP_VDD	VDD	J16_02	N.C	No Connect
J16_03	P15[1]	SPI MOSI	J16_04	P0[1]	CUSTOM
J16_05	P15[2]	SPI SCLK	J16_06	P12[0]	I2C SCL
J16_07	P15[3]	SPI SSEL	J16_08	P3[0]	CUSTOM
J16_09	P12[5]	SPI MISO	J16_10	P12[1]	I2C SDA
J16_11	P3[4]	CUSTOM	J16_12	P3[5]	CUSTOM
J16_13	P12[7]	UART RX	J16_14	P12[6]	UART TX
J16_15	P3[6]	CUSTOM	J16_16	GND	GND
J11					
Pin	PSoC 5LP Signal	PSoC 5LP Description	Pin	PSoC 5LP Signal	PSoC 5LP Description
J11_01	P0[2]	CUSTOM	J11_02	PSoC 5LP_VBUS	VBUS
J11_03	P0[3]	CUSTOM	J11_04	GND	GND
J11_05	P0[7]	CUSTOM	J11_06	PSoC 5LP_XRES	RST
J11_07	P1[6]	INT_PIN	J11_08	PSoC 5LP_SWDCCLK	SWD CLK
J11_09	P15[4]	SUSPEND	J11_10	PSoC 5LP_SWDIO	SWD IO

### A.1.3 PSoC 5LP GPIO and Custom Application Header (J6 and J7) for CY8CKIT-145-40XX

J6					
Pin	PSoC 5LP Signal	PSoC 5LP Description	Pin	PSoC 5LP Signal	PSoC 5LP Description
J6_01	PSoC 5LP_VBUS	VBUS	J6_02	GND	GND
J6_03	P12[5]	CUSTOM	J6_04	P12[0]	I2C SCL
J6_05	P12[1]	I2C SDA	J6_06	P12[7]	UART_RX
J6_07	P12[6]	UART_TX			
J7					
Pin	PSoC 5LP Signal	PSoC 5LP Description	Pin	PSoC 5LP Signal	PSoC 5LP Description
J7_01	GND	GND	J7_02	P3[0]	CUSTOM
J7_03	P3[4]	CUSTOM	J7_04	P3[5]	CUSTOM
J7_05	P3[6]	CUSTOM	J7_06	P0[2]	CUSTOM
J7_07	P0[1]	CUSTOM			

**Note:** For other kits, refer to the kit user guide to get this information.



# Revision History



## Document Revision History

Document Title: KitProg2 User Guide				
Document Number: 002-10738				
Revision	ECN Number	Issue Date	Origin of Change	Description of Change
**	5097455	01/22/2016	VJYA/ SNVN	Initial version of KitProg2 User Guide.
*A	5201134	04/01/2016	VJYA	Updated <a href="#">Introduction chapter on page 5</a> : Added “Acronyms” on page 9. Updated <a href="#">Appendix chapter on page 78</a> : Updated “Pin Assignments” on page 78: Added “PSoC 5LP GPIO and Custom Application Header (J16 and J11) for CY8CKIT-048”. Added “PSoC 5LP GPIO and Custom Application Header (J6 and J7) for CY8CKIT-145-40XX”.
*B	5268884	05/12/2016	VJYA	Added “CY8CKIT-048 PSoC Analog Coprocessor Pioneer Kit” related information in all instances across the document. Added “CY8CKIT-145-40XX PSoC 4 S-Series Prototyping Kit” related information in all instances across the document.
*C	5392257	08/05/2016	SRDS	Added “CY8CKIT-041-41XX PSoC 4100S Pioneer Kit” related information in all instances across the document.
*D	5660193	03/24/2017	NMIT / VKVK	Added “USB-SPI Bridge” related information in all instances across the document. Updated <a href="#">Introduction chapter on page 5</a> : Updated description. Updated “ <a href="#">Switching between KitProg2 Modes</a> ” on page 7: Updated description. Updated <a href="#">Figure 1-3</a> . Updated <a href="#">Ecosystem chapter on page 10</a> : Updated <a href="#">Table 2-1</a> . Updated <a href="#">Table 2-3</a> .

## Document Revision History (*continued*)

Document Title: KitProg2 User Guide				
Document Number: 002-10738				
Revision	ECN Number	Issue Date	Origin of Change	Description of Change
*D (cont.)	5660193	03/24/2017	NMIT / VKVK	<p>Updated <a href="#">KitProg2 Mode Programmer and Debugger</a> chapter on page 12: Updated description.</p> <p>Updated <a href="#">"Programming Using PSoC Creator"</a> on page 13: Updated description.</p> <p>Updated <a href="#">Figure 3-4</a>.</p> <p>Updated <a href="#">Figure 3-5</a>.</p> <p>Updated <a href="#">"Debugging Using PSoC Creator"</a> on page 16: Updated description.</p> <p>Updated <a href="#">Figure 3-8</a>.</p> <p>Removed <a href="#">"Programming and Debugging using <math>\mu</math>Vision"</a>.</p> <p>Added <a href="#">CMSIS-DAP Mode Programming and Debugging</a> chapter on page 20.</p> <p>Updated <a href="#">Mass Storage Programmer</a> chapter on page 27: Updated description.</p> <p>Updated <a href="#">"Enter or Exit the Mass Storage Programmer Mode"</a> on page 27: Updated description.</p> <p>Updated <a href="#">"Programming Using the Mass Storage Programmer"</a> on page 27: Updated description.</p> <p>Updated <a href="#">"Frequently Asked Questions on KitProg2 Mass Storage Programmer"</a> on page 29: Updated description.</p> <p>Updated <a href="#">USB-UART Bridge</a> chapter on page 30: Updated description.</p> <p>Updated <a href="#">Figure 6-1</a>.</p> <p>Updated <a href="#">USB-I2C Bridge</a> chapter on page 41: Updated description.</p> <p>Updated <a href="#">Figure 7-1</a>.</p> <p>Updated <a href="#">Figure 7-11</a>.</p> <p>Added <a href="#">USB-SPI Bridge</a> chapter on page 52.</p>

## Document Revision History (*continued*)

Document Title: KitProg2 User Guide				
Document Number: 002-10738				
Revision	ECN Number	Issue Date	Origin of Change	Description of Change
*D (cont.)	5660193	03/24/2017	NMIT / VKVK	Updated <a href="#">Developing Applications for PSoC 5LP</a> chapter on page 58: Updated description. Updated <a href="#">"Building a Custom Bootloadable Application for KitProg2"</a> on page 58: Updated description. Updated <a href="#">Figure 9-1</a> . Updated <a href="#">Figure 9-2</a> . Updated <a href="#">Figure 9-6</a> . Updated <a href="#">Figure 9-10</a> . Updated <a href="#">"Building a Normal Project for PSoC 5LP"</a> on page 67: Updated description. Updated <a href="#">Figure 9-15</a> . Updated <a href="#">Figure 9-16</a> . Updated <a href="#">Troubleshooting the KitProg2</a> chapter on page 71: Updated <a href="#">"KitProg2 Status LED Indication"</a> on page 71: Updated <a href="#">Table 10-1</a> . Updated description. Updated <a href="#">"PSoC 5LP Factory Program Restore Instructions"</a> on page 73: Updated <a href="#">"PSoC 5LP is Programmed with a Custom Application"</a> on page 73: Updated description. Updated <a href="#">"Restore PSoC 5LP KitProg2 using MiniProg3"</a> on page 76: Updated description. Updated <a href="#">Appendix</a> chapter on page 78: Updated <a href="#">"Pin Assignments"</a> on page 78: Updated description. Updated to new template.
*E	5767710	06/08/2017	NMIT	Updated <a href="#">Troubleshooting the KitProg2</a> chapter on page 71: Updated <a href="#">"KitProg2 Status LED Indication"</a> on page 71: Updated <a href="#">Table 10-1</a> .
*F	5940717	10/23/2017	NMIT	Updated <a href="#">Ecosystem</a> chapter on page 10: Updated <a href="#">Table 2-1</a> (Added new kit CY8CKIT-149 to support S3 device). Updated <a href="#">Troubleshooting the KitProg2</a> chapter on page 71: Updated <a href="#">"KitProg2 Status LED Indication"</a> on page 71: Updated <a href="#">Table 10-1</a> .
*G	5960991	11/08/2017	NMIT	Fixed typos (Replaced "CMIS" with "CMSIS" and replaced "CMISIS" with "CMSIS" in all instances across the document).

## Document Revision History (*continued*)

Document Title: KitProg2 User Guide				
Document Number: 002-10738				
Revision	ECN Number	Issue Date	Origin of Change	Description of Change
*G (cont.)	5960991	11/08/2017	NMIT	Updated <a href="#">Introduction chapter on page 5</a> : Updated "Switching between KitProg2 Modes" on page 7: Updated description. Updated <a href="#">KitProg2 Mode Programmer and Debugger chapter on page 12</a> : Updated description. Updated <a href="#">CMSIS-DAP Mode Programming and Debugging chapter on page 20</a> : Updated description. Updated "Programming and Debugging using $\mu$ Vision" on page 20: Updated description. Updated <a href="#">Mass Storage Programmer chapter on page 27</a> : Updated "Enter or Exit the Mass Storage Programmer Mode" on page 27: Updated description. Updated <a href="#">Troubleshooting the KitProg2 chapter on page 71</a> : Updated "KitProg2 Status LED Indication" on page 71: Updated <a href="#">Table 10-1</a> . Updated description.
*H	6022878	01/10/2018	NMIT	Updated <a href="#">Troubleshooting the KitProg2 chapter on page 71</a> : Updated "KitProg2 Status LED Indication" on page 71: Updated <a href="#">Table 10-1</a> . Completing Sunset Review.
*I	6043479	03/07/2018	NMIT	Updated <a href="#">Ecosystem chapter on page 10</a> : Updated <a href="#">Table 2-1</a> . Updated <a href="#">Developing Applications for PSoC 5LP chapter on page 58</a> : Updated "Building a Custom Bootloadable Application for KitProg2" on <a href="#">page 58</a> : Updated description. Added <a href="#">Figure 9-8</a> . Updated <a href="#">Figure 9-9</a> .
*J	6216916	06/25/2018	NMIT	Updated <a href="#">Ecosystem chapter on page 10</a> : Updated <a href="#">Table 2-1</a> .
*K	6367122	10/26/2018	SRDS	Updated <a href="#">Ecosystem chapter on page 10</a> : Updated <a href="#">Table 2-1</a> .